



# Control and Design for Fluids and Structures

Enrique Zuazua

FAU & AvH

[enrique.zuazua@fau.de](mailto:enrique.zuazua@fau.de)

<http://paginaspersonales.deusto.es/enrique.zuazua/>

**April 2020**

# Table of Contents

- 1 Control
- 2 The Calculus of Variations
- 3 Controllability
- 4 Optimal Design
- 5 Optimization
- 6 Perspectives

# Control theory and applications

## Mechanics

Vehicles (guidance, dampers, ABS, ESP, ...),  
Aeronautics, aerospace (shuttle, satellites), robotics

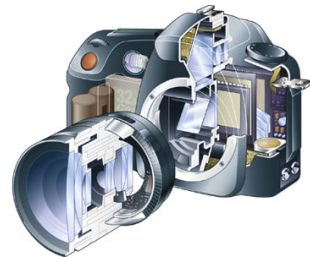
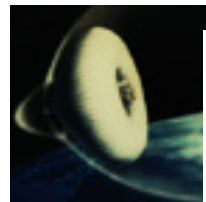

## Biology, medicine

Predator-prey systems, bioreactors, epidemiology,  
medicine (pacemakers, laser surgery)

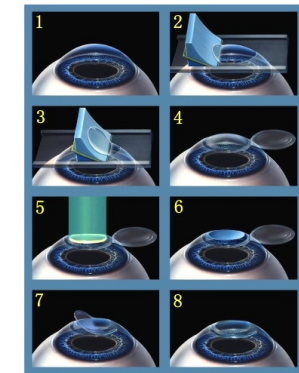
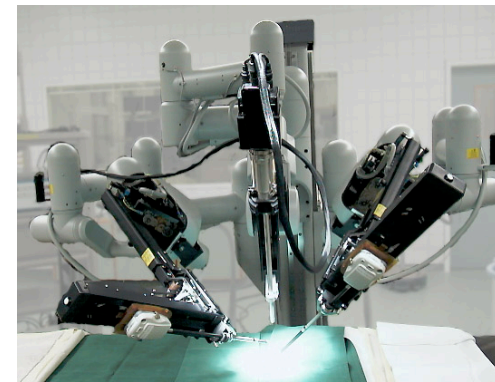
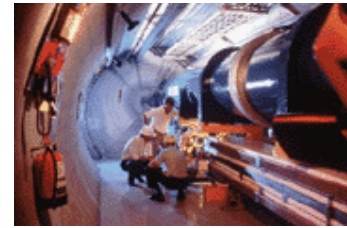

## Electricity, electronics

RLC circuits, thermostats, regulation, refrigeration, computers, internet  
and telecommunications in general, photography and digital video

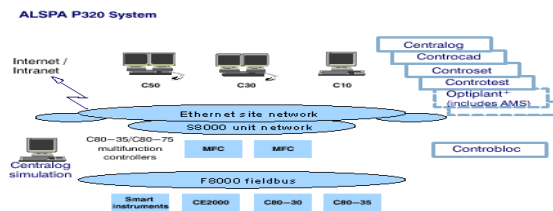
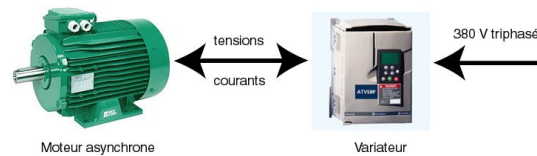

## Economics

Gain optimization, control of financial flux,  
Market prevision



19.86	37.52	17.12	-0.06	1.81%
36.75	17.02	42.15	+0.75	0.48%
17.47	40.86	27.09	+0.13	2.09%
42.45	26.07	22.47	+0.46	-5.12%
27.15	21.71	23.37	-1.26	3.30%
22.59	22.74	391.66	+12.51	0.78%
29.97	391.70	377.43	+0.74	1.69%
391.70	377.43	391.66	+12.51	1.22%
95.67	93.96	95.61	+0.74	0.78%
25.32	24.74	25.22	+0.42	1.69%
24.89	24.35	24.82	+0.30	1.22%
57.55	55.00	57.27	+0.68	1.22%

## Chemistry

Chemical kinetics, engineering process, petroleum, distillation, petrochemical industry

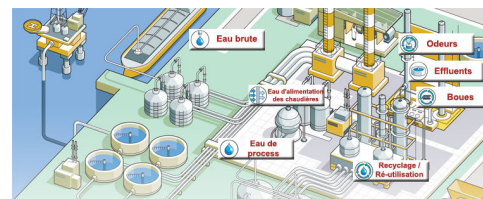

## *Origins*



# THE ORIGINS:

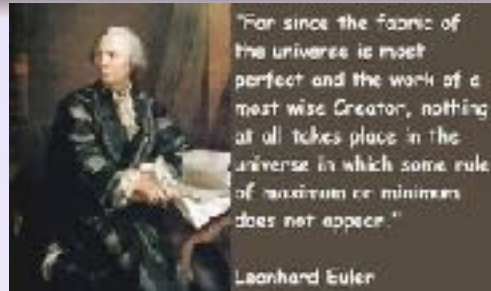

*"... if every instrument could accomplish its own work, obeying or anticipating the will of others ... if the shuttle weaved and the pick touched the lyre without a hand to guide them, chief workmen would not need servants, nor masters slaves."*

Chapter 3, Book 1, of the monograph "Politics" by [Aristotle \(384-322 B. C.\)](#).

**Main motivation:** The need of automatizing processes to let the human being gain in liberty, freedom, and quality of life.

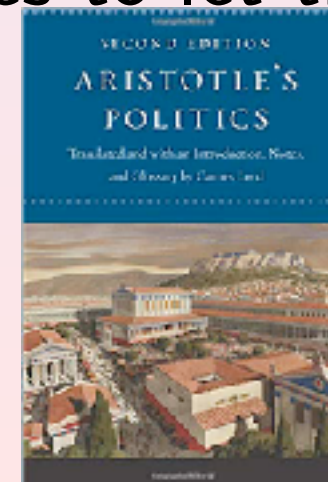

# An example: noise reduction

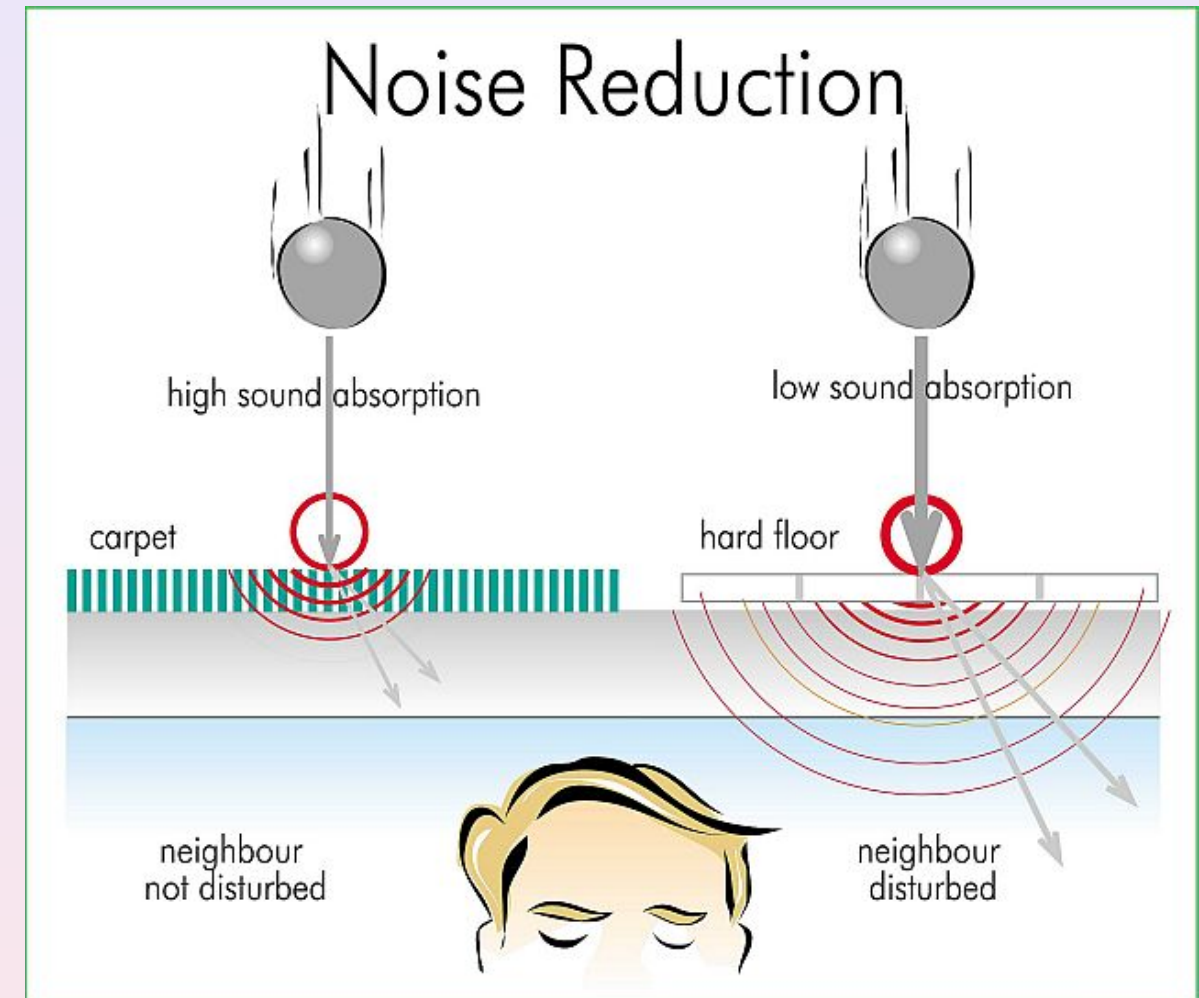
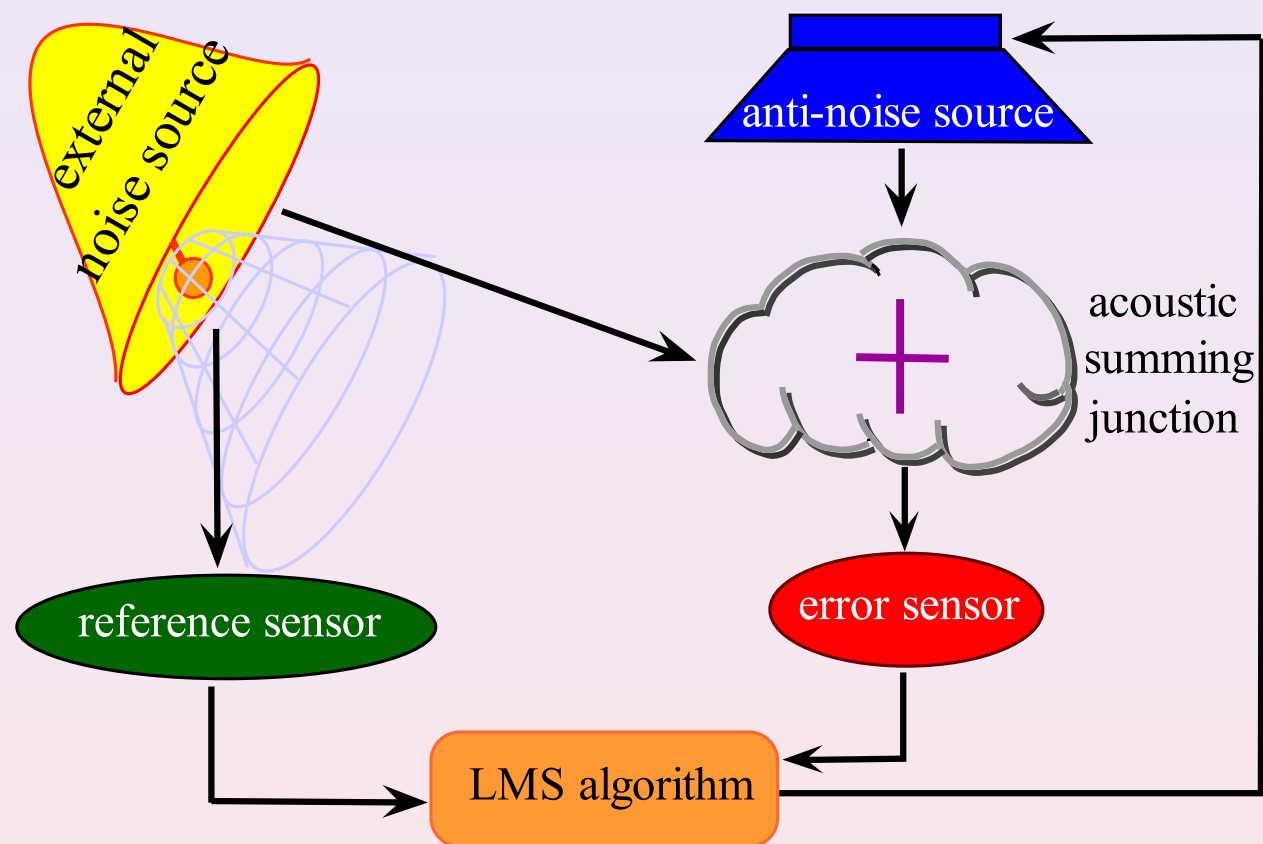

Acoustic noise reduction

# Other applications of noise reduction

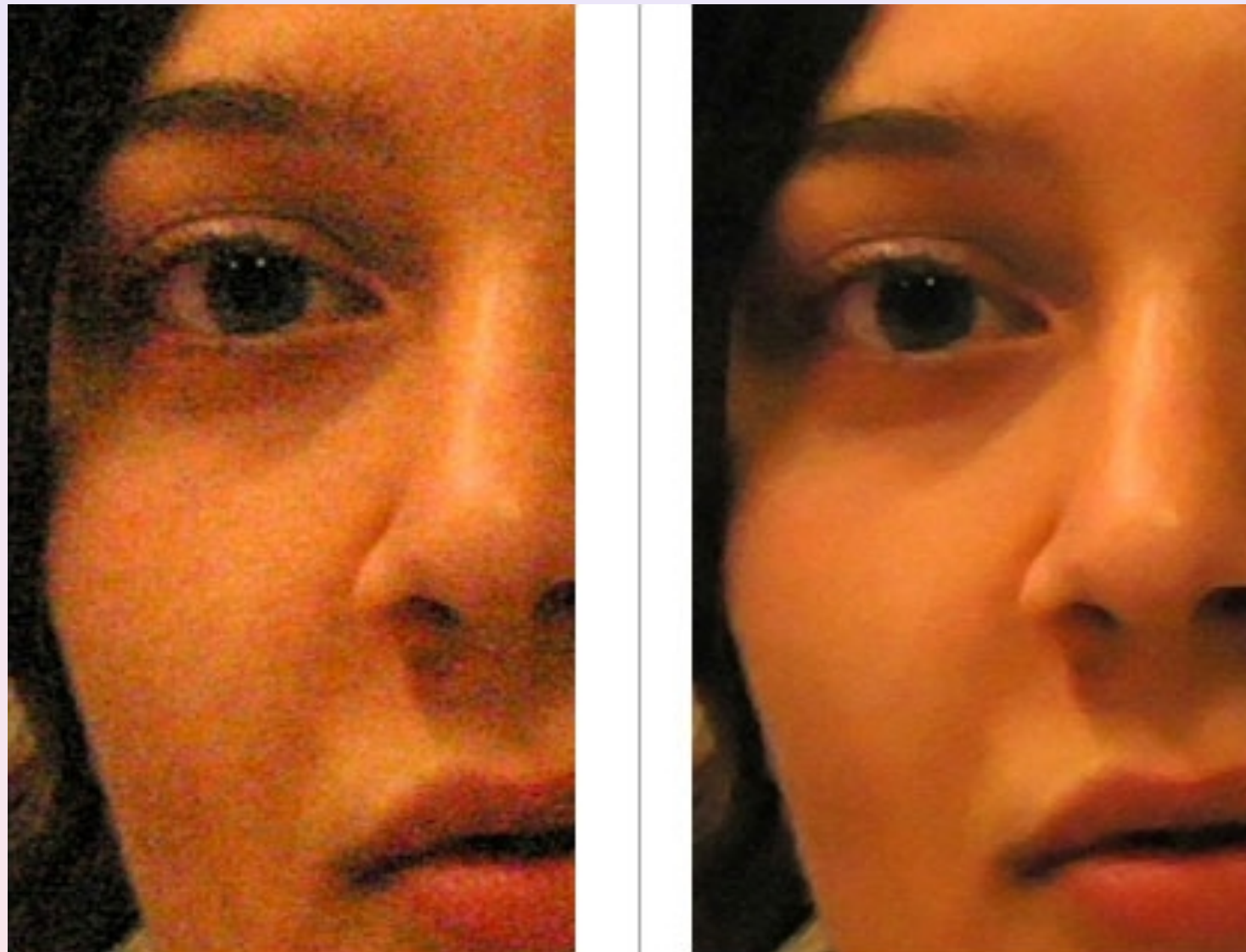

# Gaussian filters

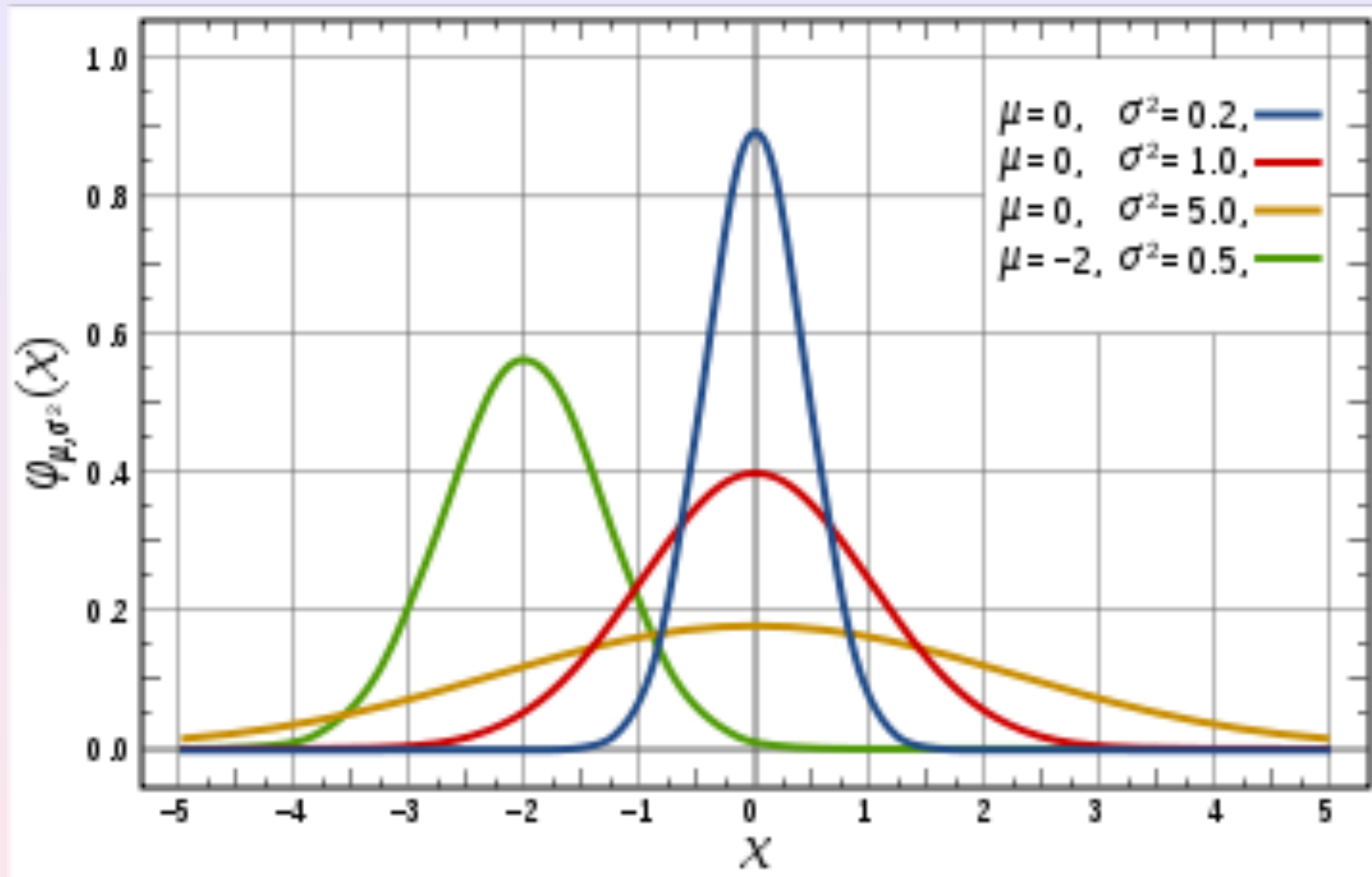

$$u(x) = [G(\cdot) \star f(\cdot)](x); \quad G(x) = (4\pi)^{-N/2} \exp(-|x|^2/4).$$





*Control in an information rich World, SIAM, R. Murray Ed., 2003.*

# Table of Contents

- 1 Control
- 2 The Calculus of Variations**
- 3 Controllability
- 4 Optimal Design
- 5 Optimization
- 6 Perspectives



## The Calculus of Variations = The search of minimality

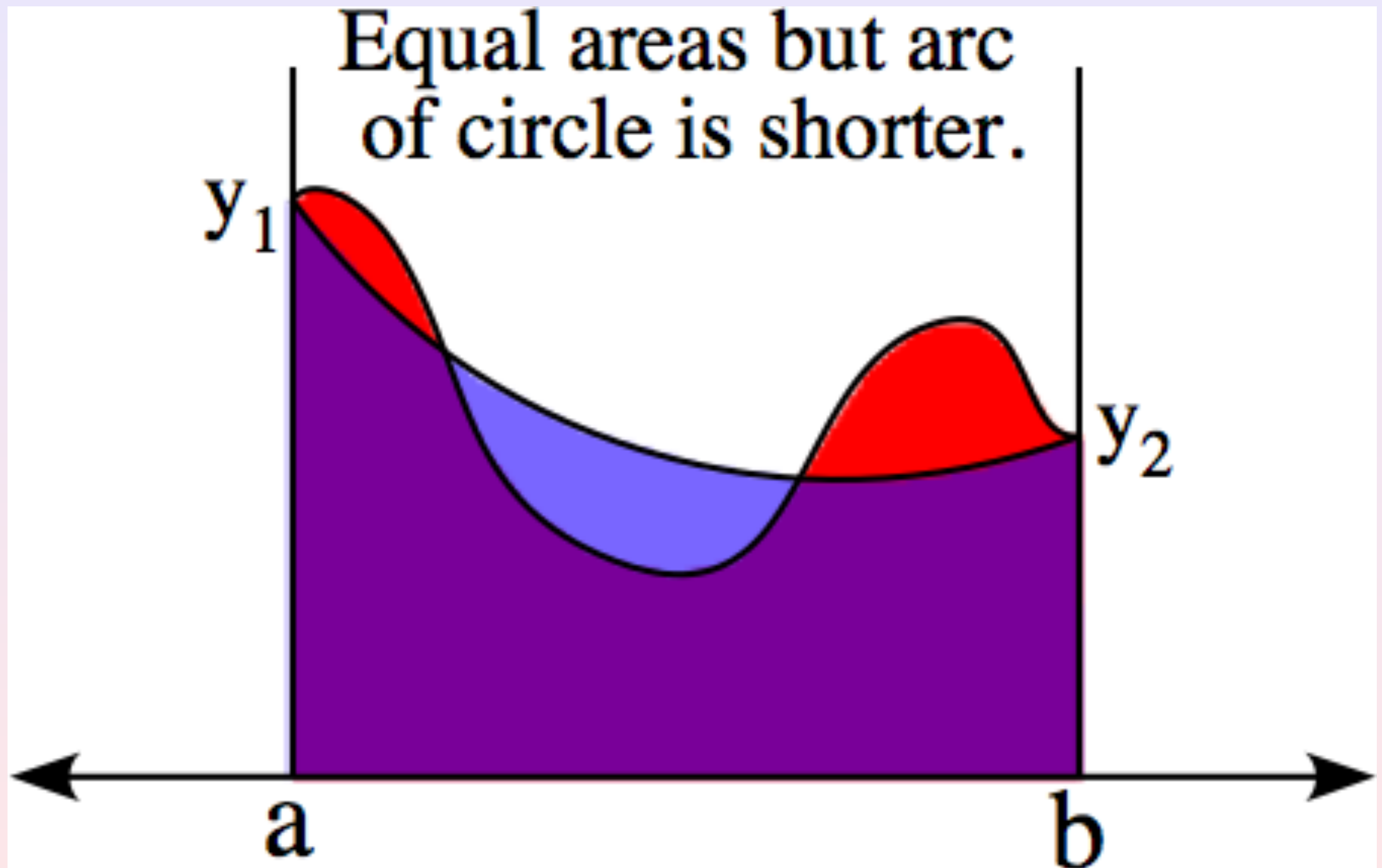

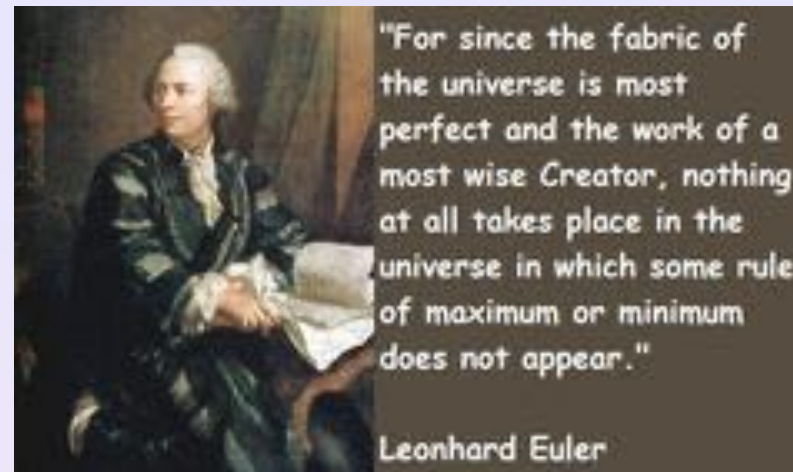

*Leonhard Euler(1707-1783): For since the fabric of the universe is most perfect and the work of a most wise creator, nothing at all takes place in the universe in which some rule of the maximum or minimum does not appear.*

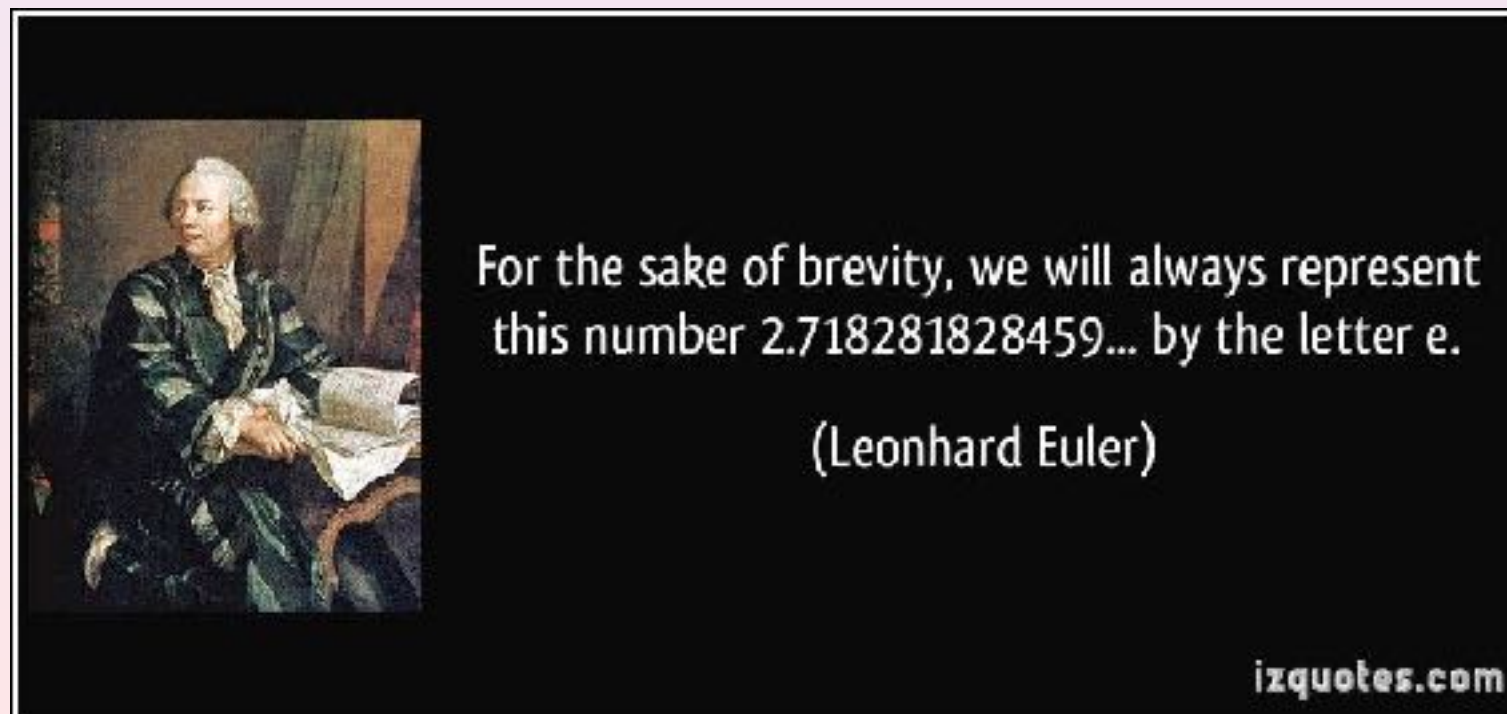

# Isoperimetric inequalities

The isoperimetric inequality states, for the length  $L$  of a closed curve and the area  $A$  of the planar region that it encloses, that

$$4\pi A \leq L^2,$$

and that equality holds if and only if the curve is a circle.

**Dido's problem**; named after Dido, the legendary founder and first queen of Carthage.

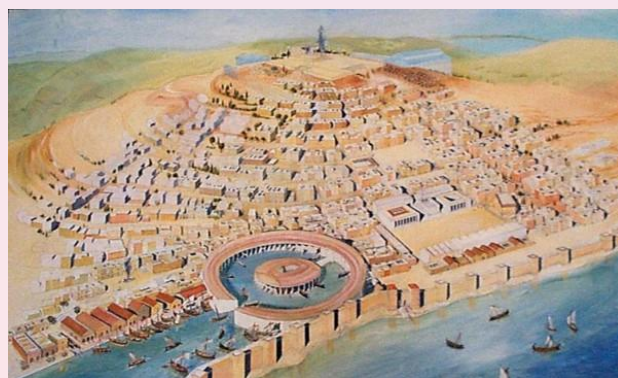

Carthage & Cologne



# Geodesic curves

The curve of shortest length, **geodesic**, connecting two points.

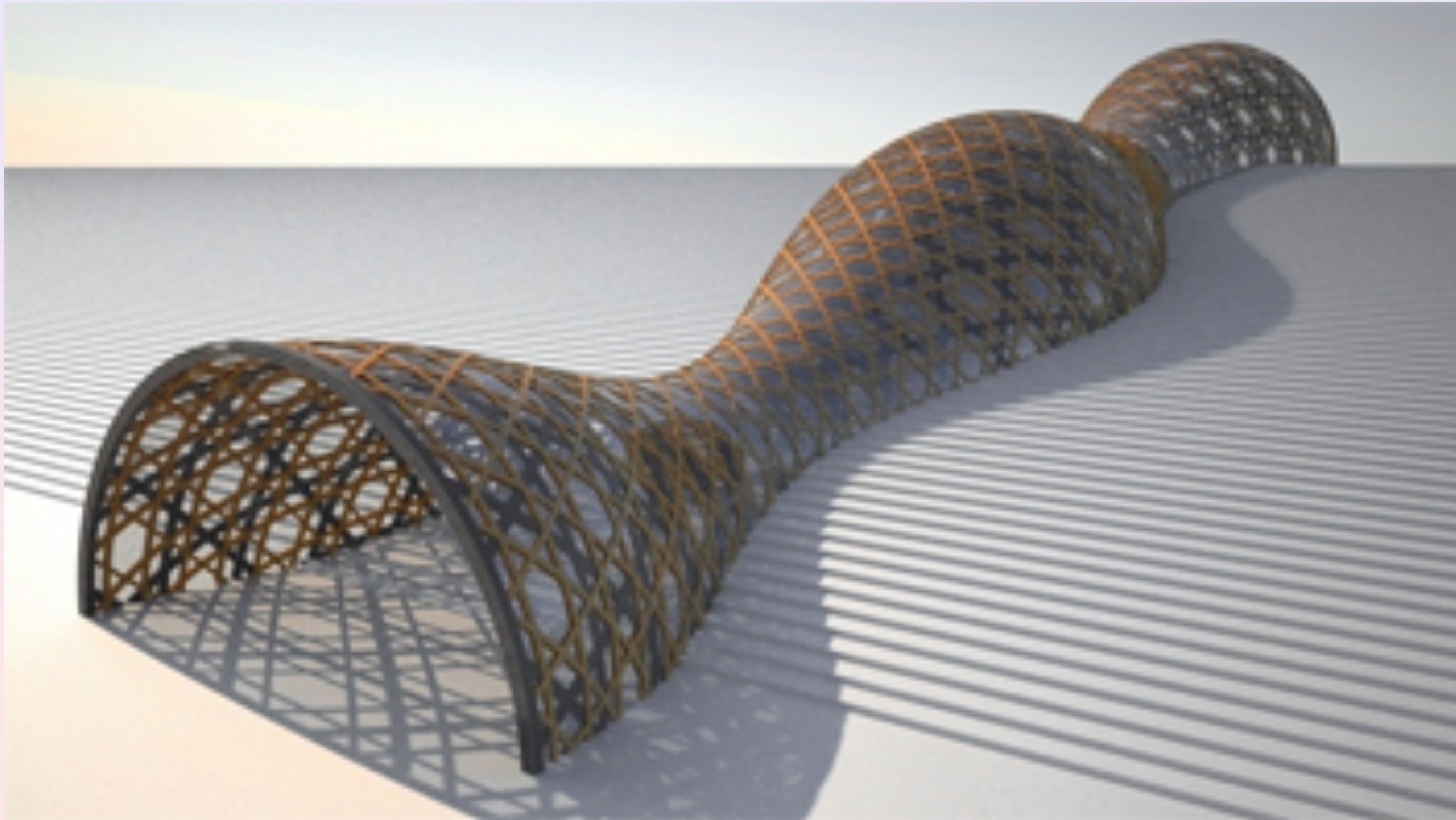

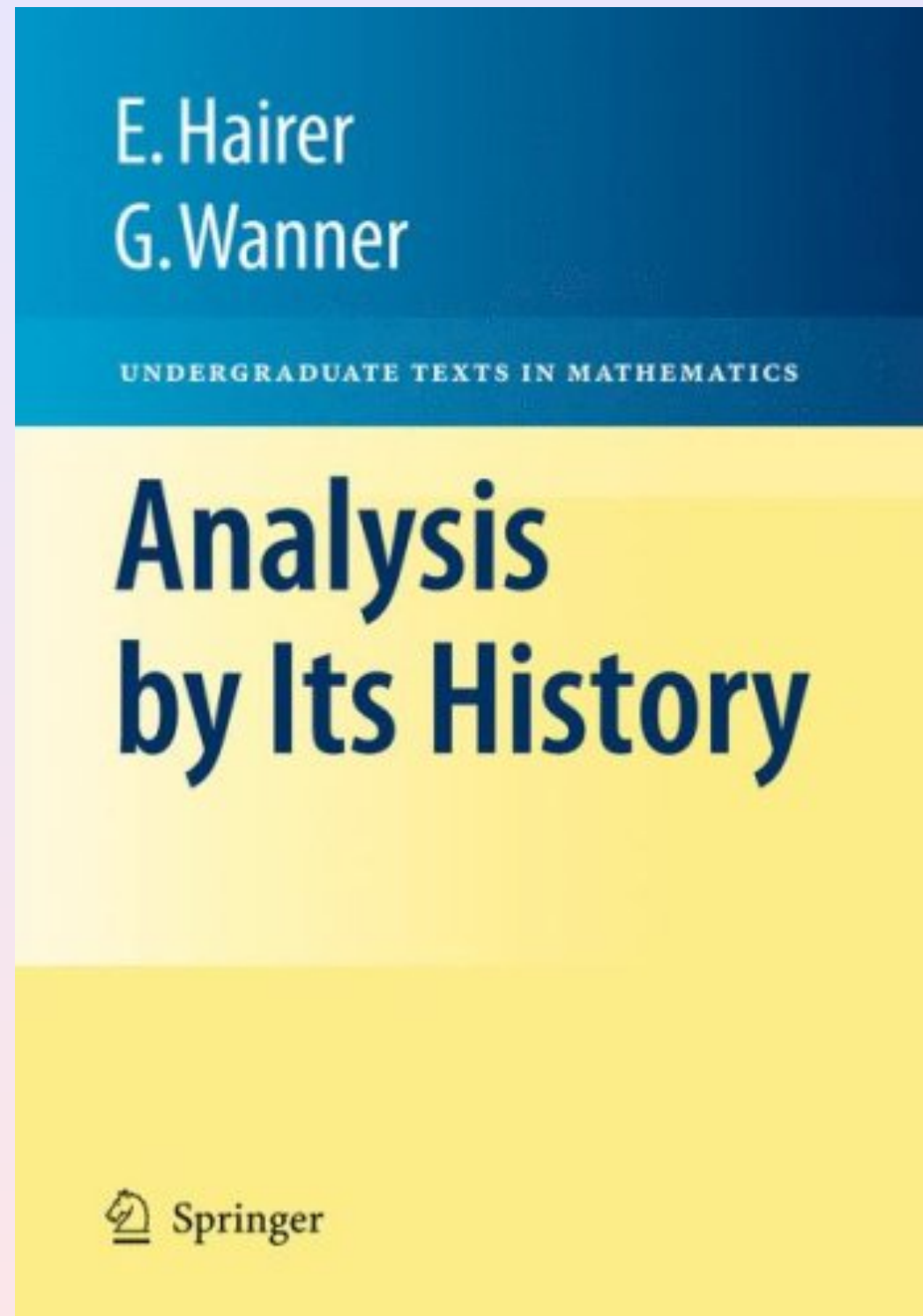

# Fermat's principle/Snellious law

**Fermat's principle:** light follows the path of shortest optical length connecting two points, where the optical length depends upon the material of the medium.

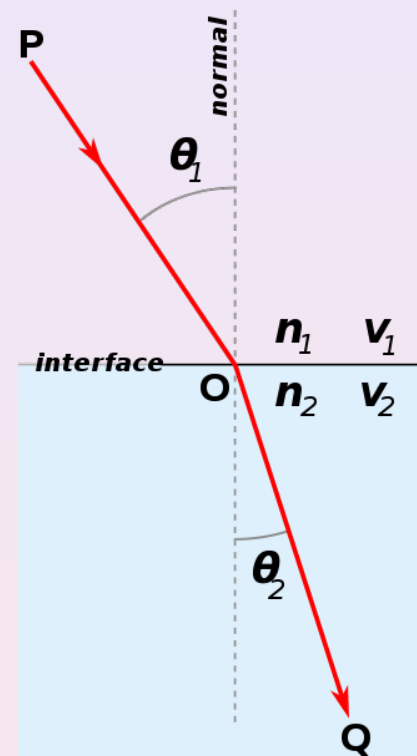

$$\frac{\sin(\theta_1)}{\sin(\theta_2)} = \frac{v_1}{v_2} = \frac{n_2}{n_1}.$$

Named after the dutch astronomer Willebrord Snellius (1580 - 1626).  
Pierre de Fermat (1601 - 1665).



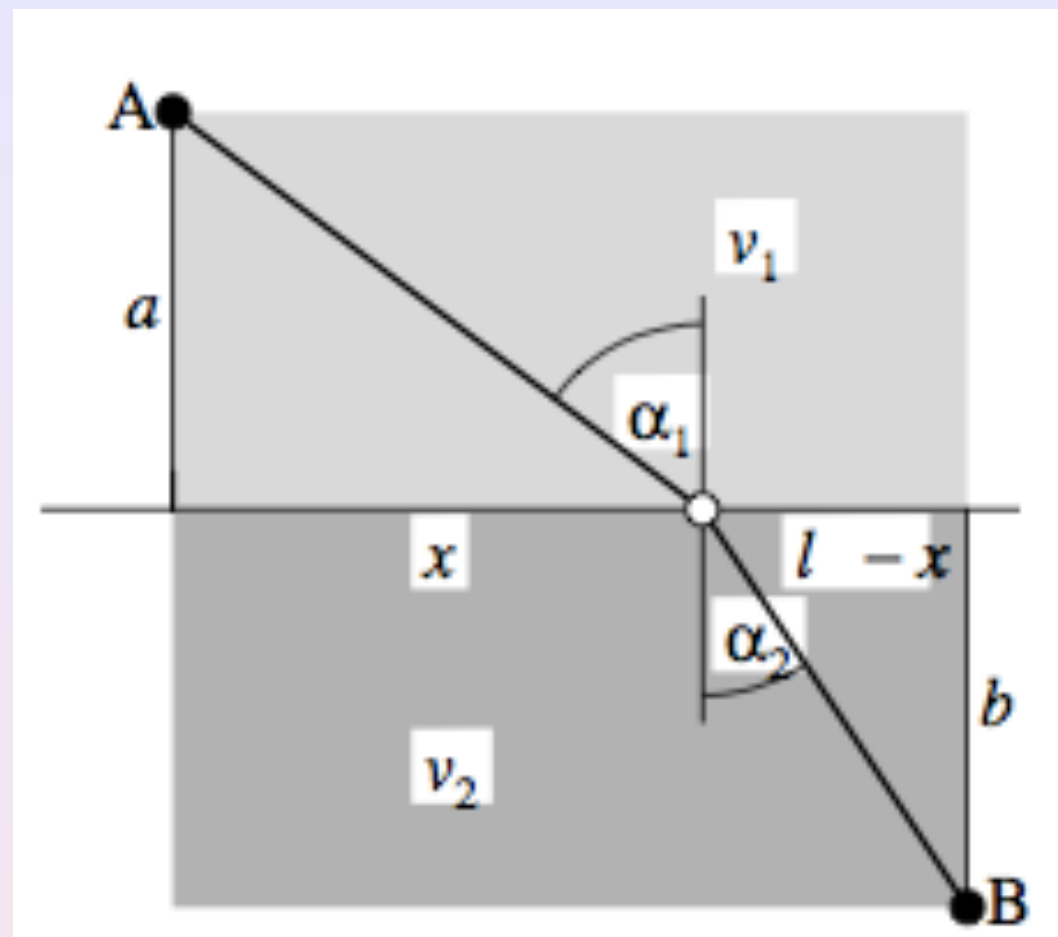

To find  $x$  s. t.

$$T = \frac{\sqrt{a^2 + x^2}}{v_1} + \frac{\sqrt{b^2 + (l - x)^2}}{v_2}.$$

Fermat found the problem too difficult for an analytical treatment (**I admit that this problem is not one of the easiest**). The computations were then proudly performed by Leibniz (1684)

$$T' = \frac{1}{v_1} \frac{2x}{2\sqrt{a^2 + x^2}} - \frac{1}{v_2} \frac{2(\ell - x)}{2\sqrt{b^2 + (\ell - x)^2}}.$$

Observing that  $\sin(\alpha_1) = x/\sqrt{a^2 + x^2}$ ;  $\sin(\alpha_2) = (\ell - x)/\sqrt{b^2 + (\ell - x)^2}$  we see that this derivative vanishes whenever

$$\frac{\sin(\theta_1)}{\sin(\theta_2)} = \frac{v_1}{v_2}.$$

Furthermore:

$$T'' = \frac{1}{v_1} \frac{a^2}{(a^2 + x^2)^{3/2}} + \frac{1}{v_2} \frac{b^2}{(b^2 + (\ell - x)^2)^{3/2}} > 0,$$

showing that the critical point is the minimizer.

# Optimal transport

In mathematics and economics, transportation theory refers to the study of optimal transportation and allocation of resources. The problem was formalized by the French mathematician **Gaspard Monge** in 1781 (“Sur la théorie des déblais et des remblais” (Mém. de l’Acad. de Paris, 1781))

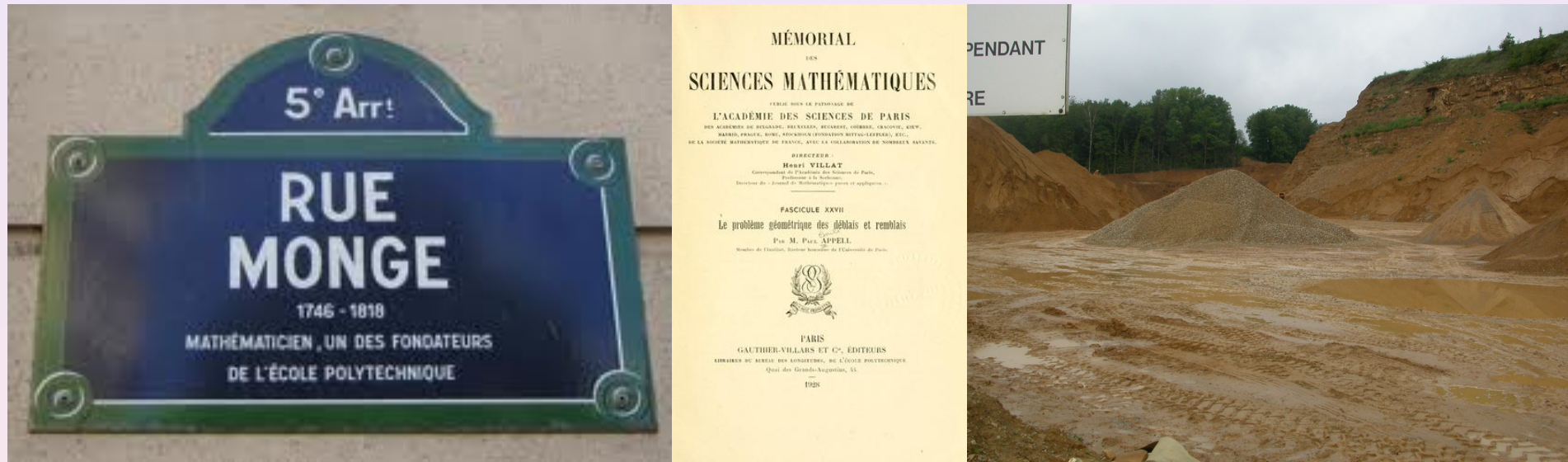

But the origins of the potential applications of the idea of optimal transport and geodesic paths goes back to the ancient Egypt where the “harpenodaptai” had as main task drawing long straight lines on the sand of the desert.

## Minimal surfaces

Minimal surfaces are defined as surfaces with zero mean curvature. Finding a minimal surface of a boundary with specified constraints is a problem in the Calculus of Variations and is sometimes known as **Plateau's problem**.

Physical models of area-minimizing minimal surfaces can be made by dipping a wire frame into a soap solution, forming a soap film, which is a minimal surface whose boundary is the wire frame.

Enneper's surface:

$$x = u(1 - u^2/3 + v^2)/3; y = -v(1 - v^2/3 + u^2)/3; z = (u^2 - v^2)/3.$$

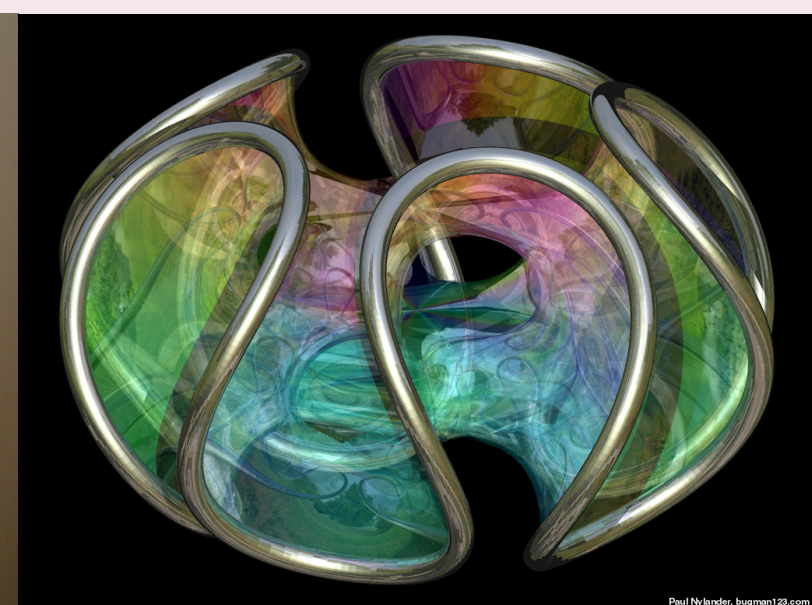
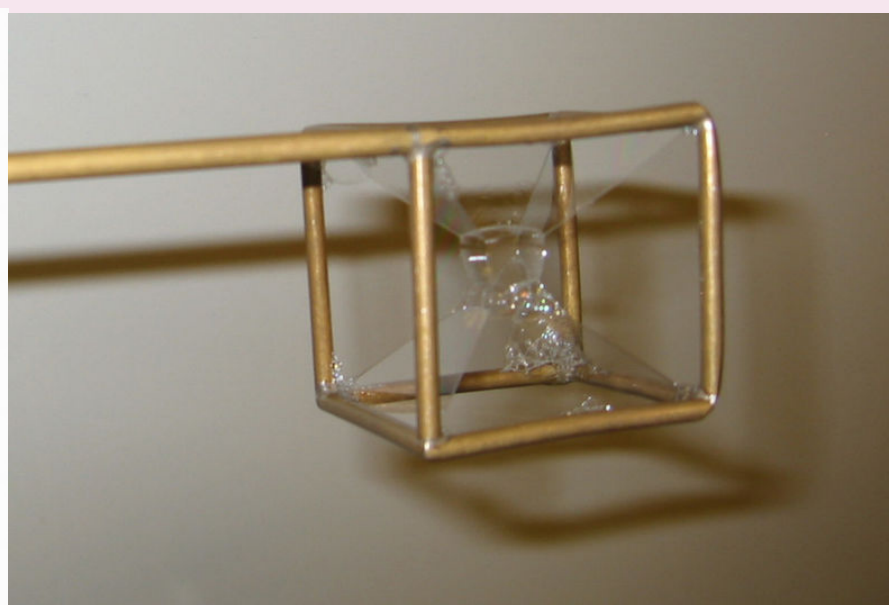



# Computational minimization

$$J(u^*) = \min_{u \in \mathcal{U}} J(u).$$

Gradient methods:

$$u_{k+1} = u_k - \rho \nabla J(u_k).$$

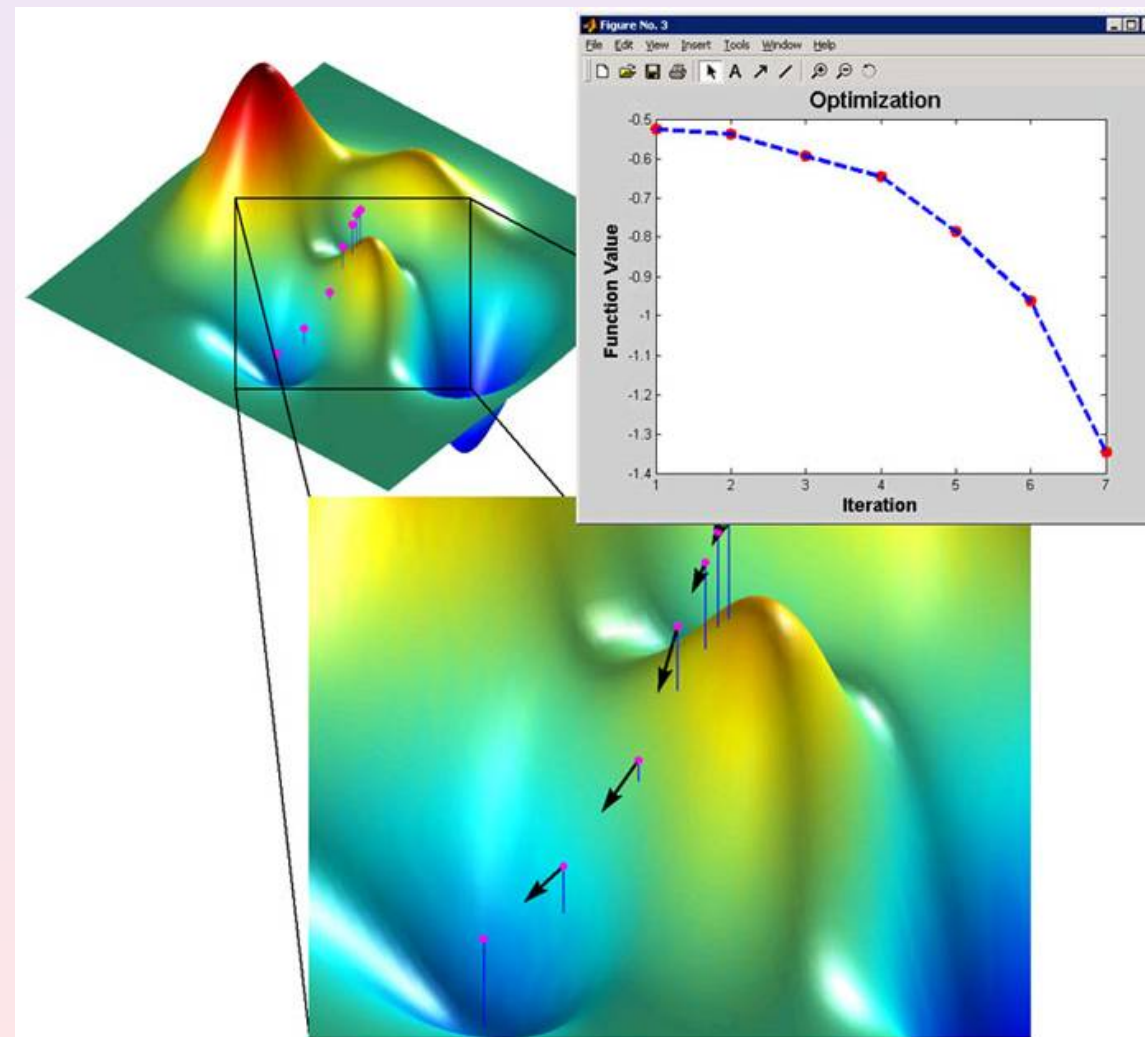

# Montecarlo methods

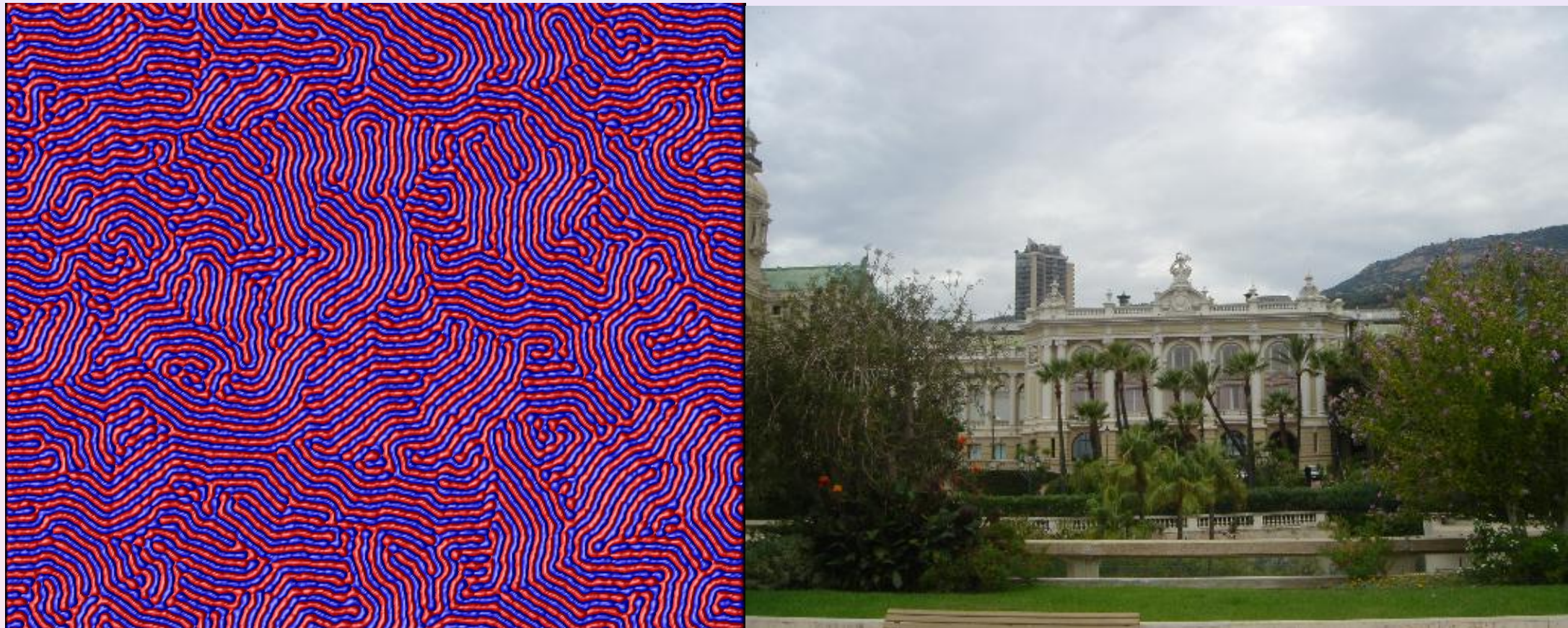

**When the landscape of the functional to be minimised is too complex, computing gradients may become impossible. Then, the application of stochastic algorithms may be a must.**



# Table of Contents

- 1 Control
- 2 The Calculus of Variations
- 3 Controllability**
- 4 Optimal Design
- 5 Optimization
- 6 Perspectives

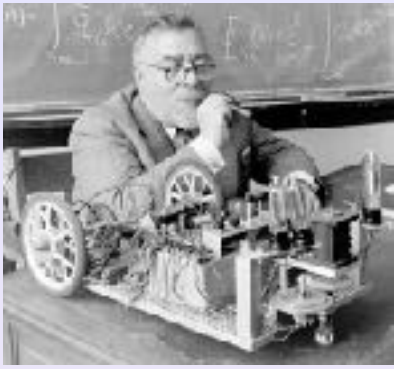

“Cybernétique” was proposed by the French physicist **A.-M. Ampère** in the XIX Century to design the nonexistent science of process controlling. This was quickly forgotten until 1948, when **Norbert Wiener** (1894–1964) chose “**Cybernetics**” as the title of his famous book.

Wiener defined Cybernetics as “ **the science of control and communication in animals and machines**” .

In this way, he established the connection between Control Theory and Physiology and anticipated that, in a desirable future, engines would obey and imitate human beings.



# Robotic arm



Let  $n, m \in \mathbb{N}^*$  and  $T > 0$  and consider the following linear finite-dimensional system

$$x'(t) = Ax(t) + Bu(t), \quad t \in (0, T); \quad x(0) = x^0. \quad (1)$$

In (1),  $A$  is a  $n \times n$  real matrix,  $B$  is of dimensions  $n \times m$  and  $x^0$  is the initial state of the system in  $\mathbb{R}^n$ . The function  $x : [0, T] \rightarrow \mathbb{R}^n$  represents the *state* and  $u : [0, T] \rightarrow \mathbb{R}^m$  the *control*.

¿Can we control the state  $x$  of  $n$  components with only  $m$  controls, even if  $n \gg m$ ?

## Theorem

(1958, Rudolf Emil Kálmán (1930 - 2016)) System (1) is controllable iff

$$\text{rank}[B, AB, \dots, A^{n-1}B] = n.$$

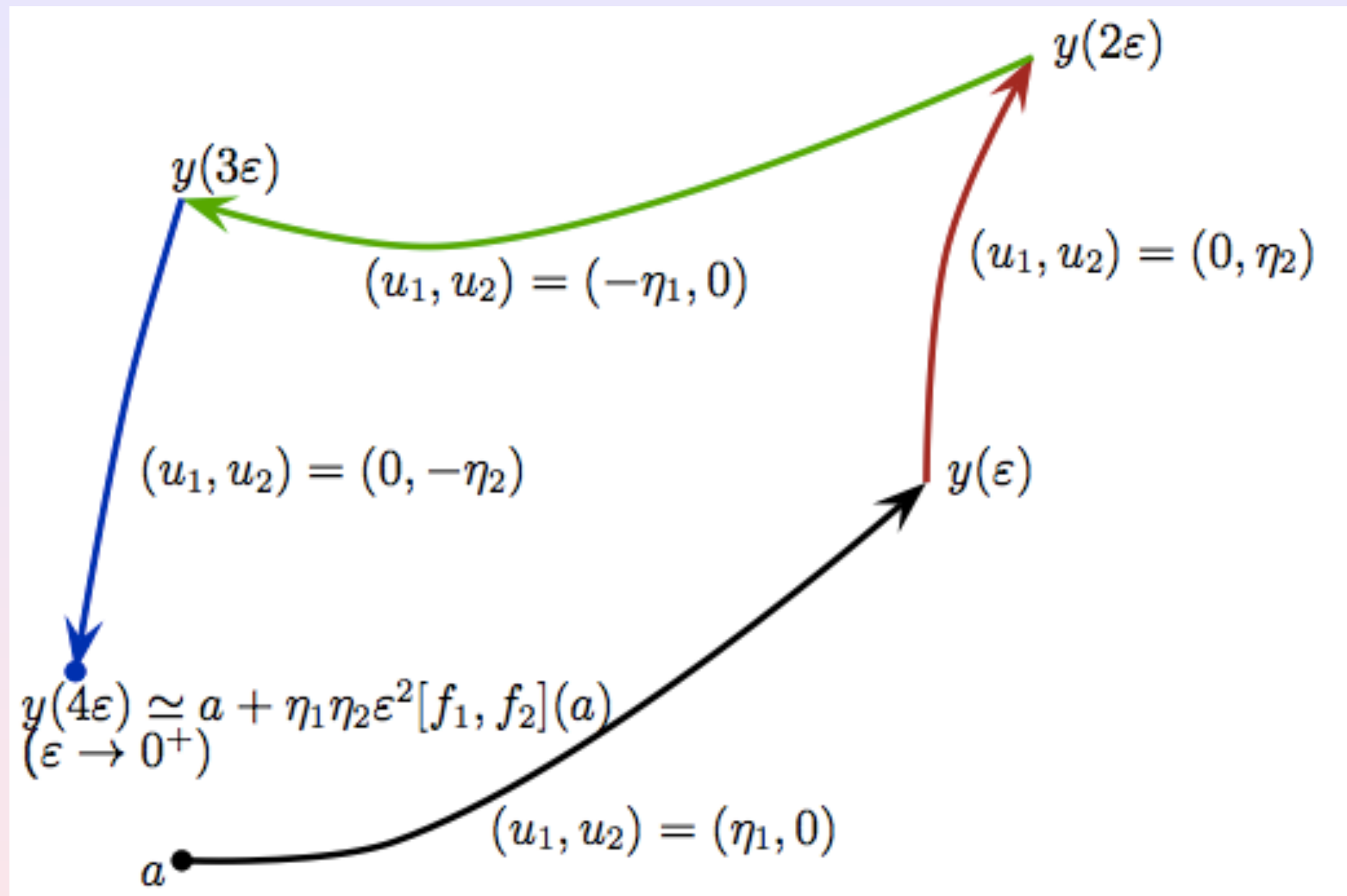

J. M. Coron, June 2011.

## Proof:

From the variation of constants formula:

$$x(t) = e^{At}x^0 + \int_0^t e^{A(t-s)}Bu(s)ds = e^{At}x^0 + \int_0^t \sum_{k \geq 0} \frac{(t-s)^k}{k!} A^k Bu(s)ds.$$

By Cayley<sup>1</sup>-Hamilton's <sup>2</sup> theorem  $A^k$  for  $k \geq n$  is a linear combination of  $I, A, \dots, A^{n-1}$ .

---

<sup>1</sup>Arthur Cayley (UK, 1821 - 1895)

<sup>2</sup>William Rowan Hamilton (Ireland, 1805 - 1865)



# An example: Nelson's car.

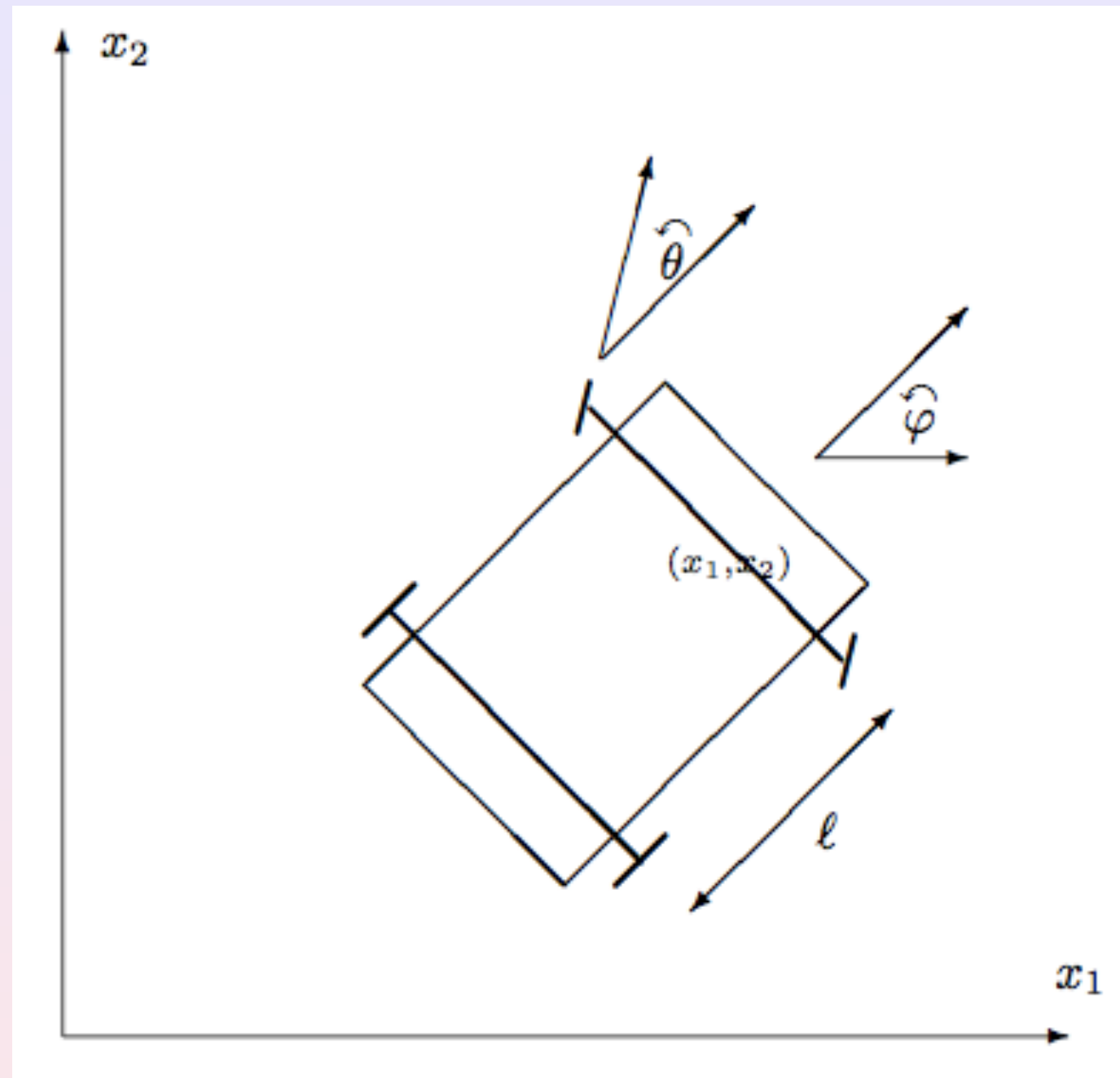

Two controls suffice to control a four-dimensional dynamical system.

E. Sontag, *Mathematical control theory*, 2nd ed., Texts in Applied Mathematics, vol.6, Springer-Verlag, New York, 1998.

# Table of Contents

- 1 Control
- 2 The Calculus of Variations
- 3 Controllability
- 4 Optimal Design**
- 5 Optimization
- 6 Perspectives

# The optimal pancake

## MailOnline

**The perfect pancake? Easy, just follow this formula ...  $100 - [10L - 7F + C(k - C) + T(m - T)] / (S - E)$**

By [Daily Mail Reporter](#)

Last updated at 9:49 AM on 24th February 2009

With Shrove Tuesday tomorrow it was perhaps inevitable that an eager scientist would apply their skills to creating the perfect pancake.

Maths expert Dr Ruth Fairclough stepped up to the challenge, unveiling a complex algebra formula to help chefs nail the dish on the day.

The 34-year-old senior lecturer of mathematics and statistics worked out the food formula because her two daughters loved eating pancakes so much.

Dr Ruth, who teaches at Wolverhampton University found that  $100 - [10L - 7F + C(k - C) + T(m - T)] / (S - E)$  created the tastiest snack.

In the complex formula L represents the number of lumps in the batter and C equals its consistency.

The letter F stands for the flipping score, k is the ideal consistency and T is the temperature of the pan.

Ideal temp of pan is represented by m, S is the length of time the batter stands before cooking and E is the length of time the cooked pancake sits before being eaten.





# Optimal shape design in aeronautics.

- **Objective:** To modify the shape of the airplane so to improve its efficiency, security, reduce noise, energy consumption, reduce drag, augment lift,...
- **Point of view:** That of the wind tunnel. The airplane is fixed while air is flowing around.
- **Variations:** When modifying the shape of the airplane, the way air is flowing around is modified, and the pressure field it applies into the airplane as well. The aerodynamical properties of the airplane are modified.



# Tools.

- **Computational fluid mechanics:** It allows to simulate the flow of air around a cavity.
- **Optimization:** It allows building an iterative algorithm to improve performance.

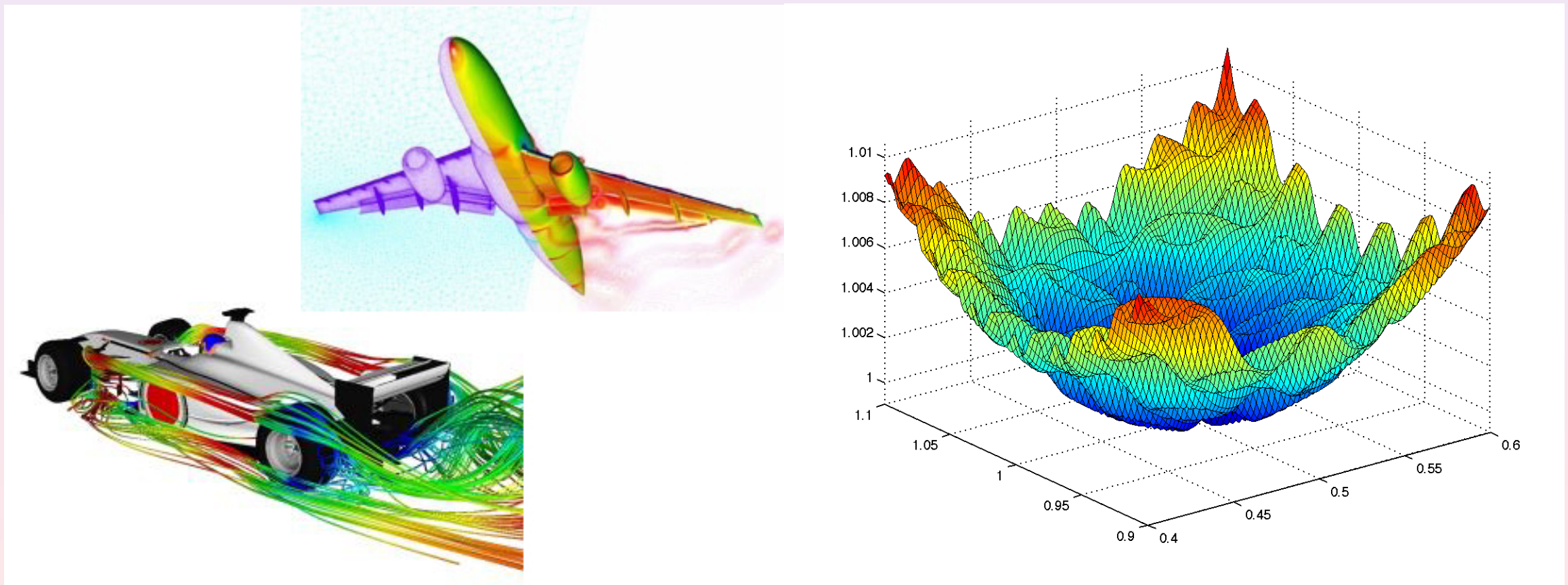



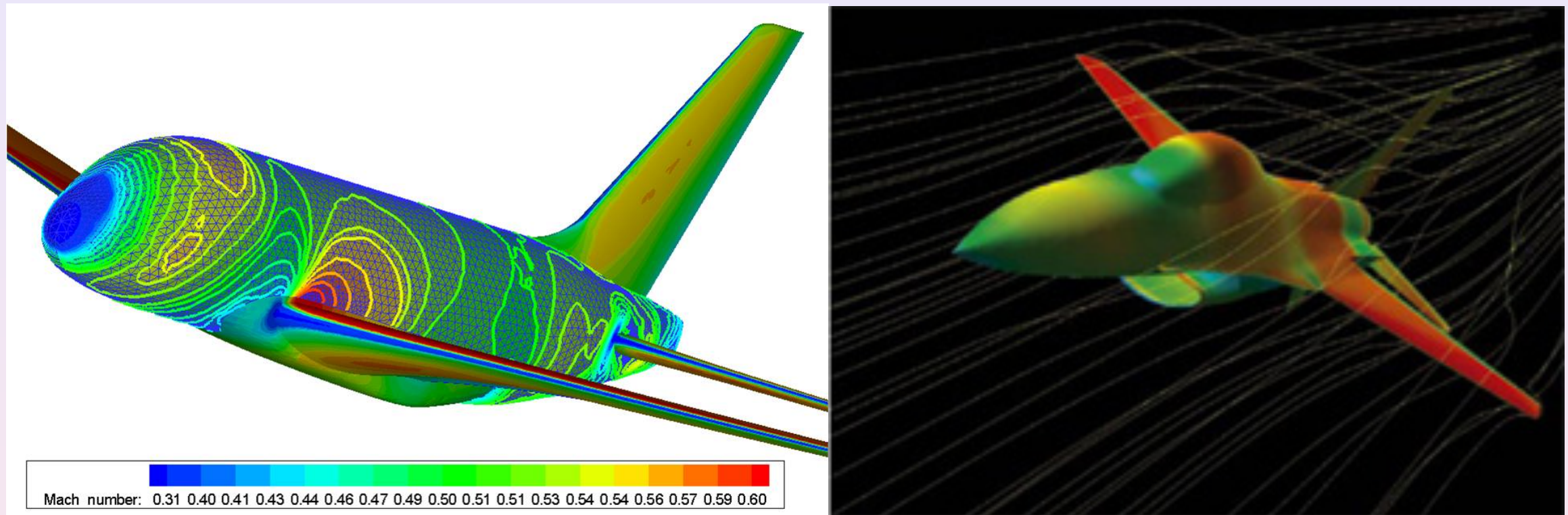

Computed pressure field over the surface of the airplane and flow lines of particles of air.

The method consists on formulating the problem in the context of the Calculus of Variations. To minimize

$$J(\Omega^*) = \min_{\Omega \in \mathcal{C}_{ad}} J(\Omega)$$

where  $\mathcal{C}_{ad}$  is the class of **admissible shapes**  $\Omega$ , and  $J =$  is the **cost functional** measuring the efficiency of the design (drag, lift,...)

$J$  depends on  $\Omega$  but not directly, rather through  $u(\Omega)$ , the solution of the air-dynamics in the exterior of the airplane.

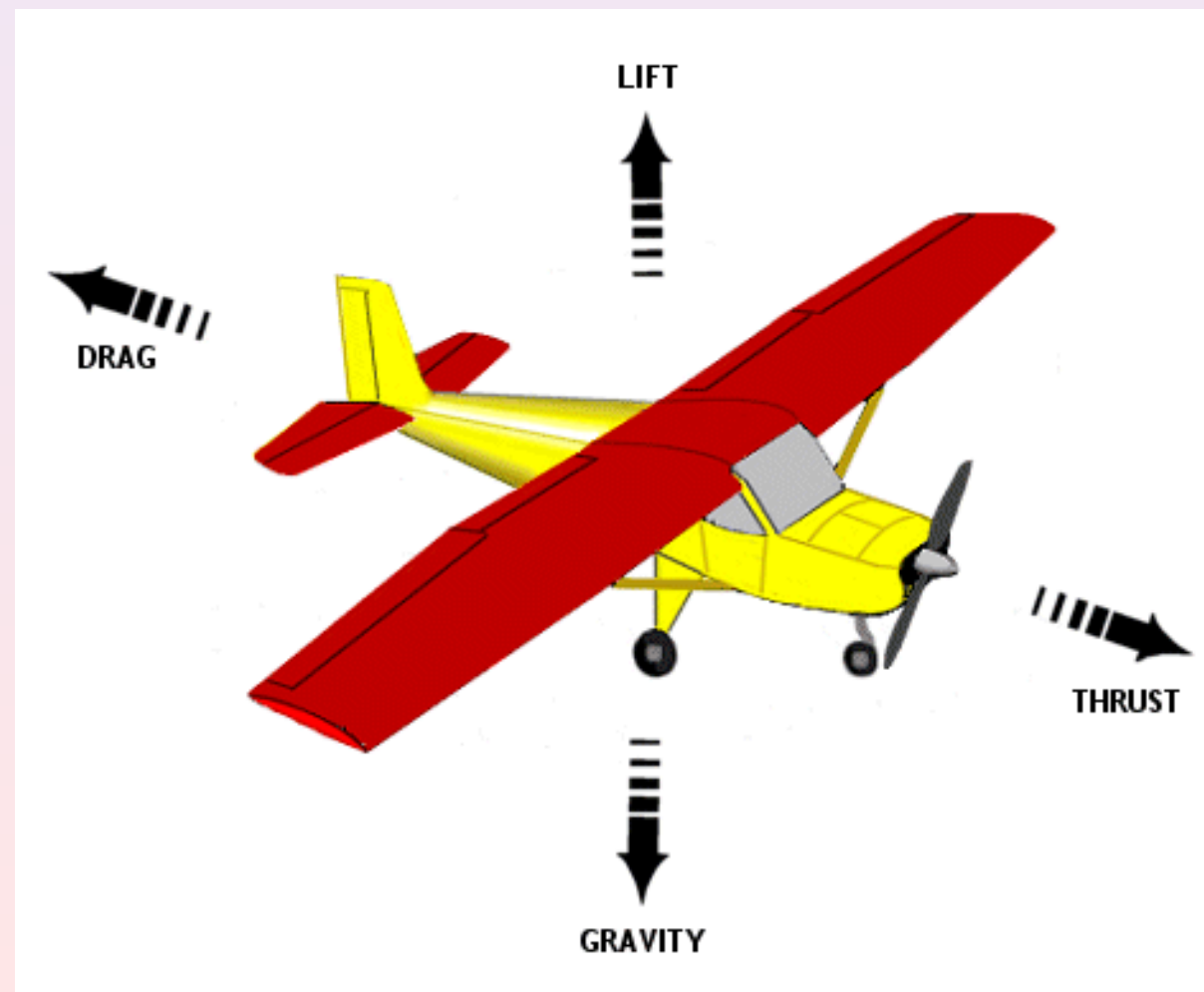

# Leonhard Euler

(1707-1783) derived the equations for the motion of perfect fluids, in the absence of viscosity:

$$u_t + u \cdot \nabla u = \nabla p.$$

But D'Alembert observed that the flight of birds would be impossible according to that model.

Claude Louis Marie Henri Navier (1785-1836) and Sir George Gabriel Stokes (1819-1903) much later incorporated the viscosity term:

$$u_t - \nu \Delta u + u \cdot \nabla u = \nabla p.$$



There are many open complex problems in the field of Fluid Mechanics.



Fluid Mechanics is one of the most important areas of Physics because of its impact on our life : air, water, blood,...

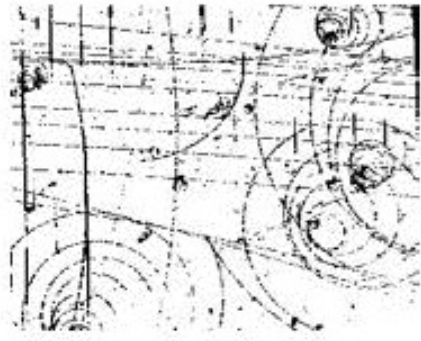

Yang-Mills and Mass Gap

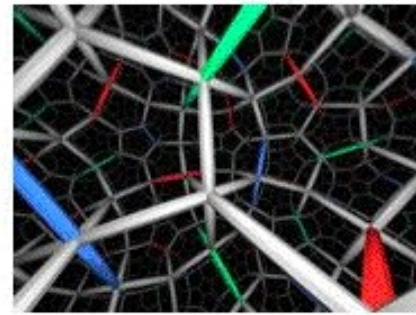

Poincaré Conjecture

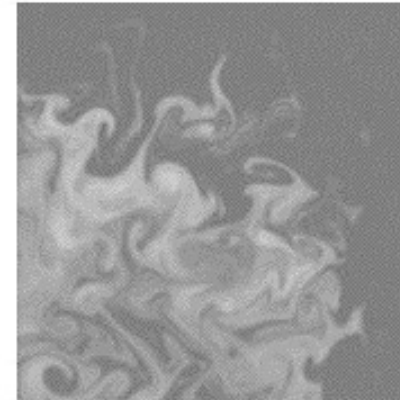

Navier-Stokes Equation



Birch and Swinnerton-Dyer Conjecture



Riemann Hypothesis



P vs NP Problem



Hodge Conjecture

## The millenium problems



## Navier-Stokes equation

Waves follow our boat as we meander across the lake, and turbulent air currents follow our flight in a modern jet. Mathematicians and physicists believe that an explanation for and the prediction of both the breeze and the turbulence can be found through an understanding of solutions to the Navier-Stokes equations. Although these equations were written down in the 19th Century, our understanding of them remains minimal. The challenge is to make substantial progress toward a mathematical theory which will unlock the secrets hidden in the Navier-Stokes equations.

<http://www.claymath.org/millennium-problems/navierstokes-equation>

The science program is still ongoing to a large extent thanks to computers.

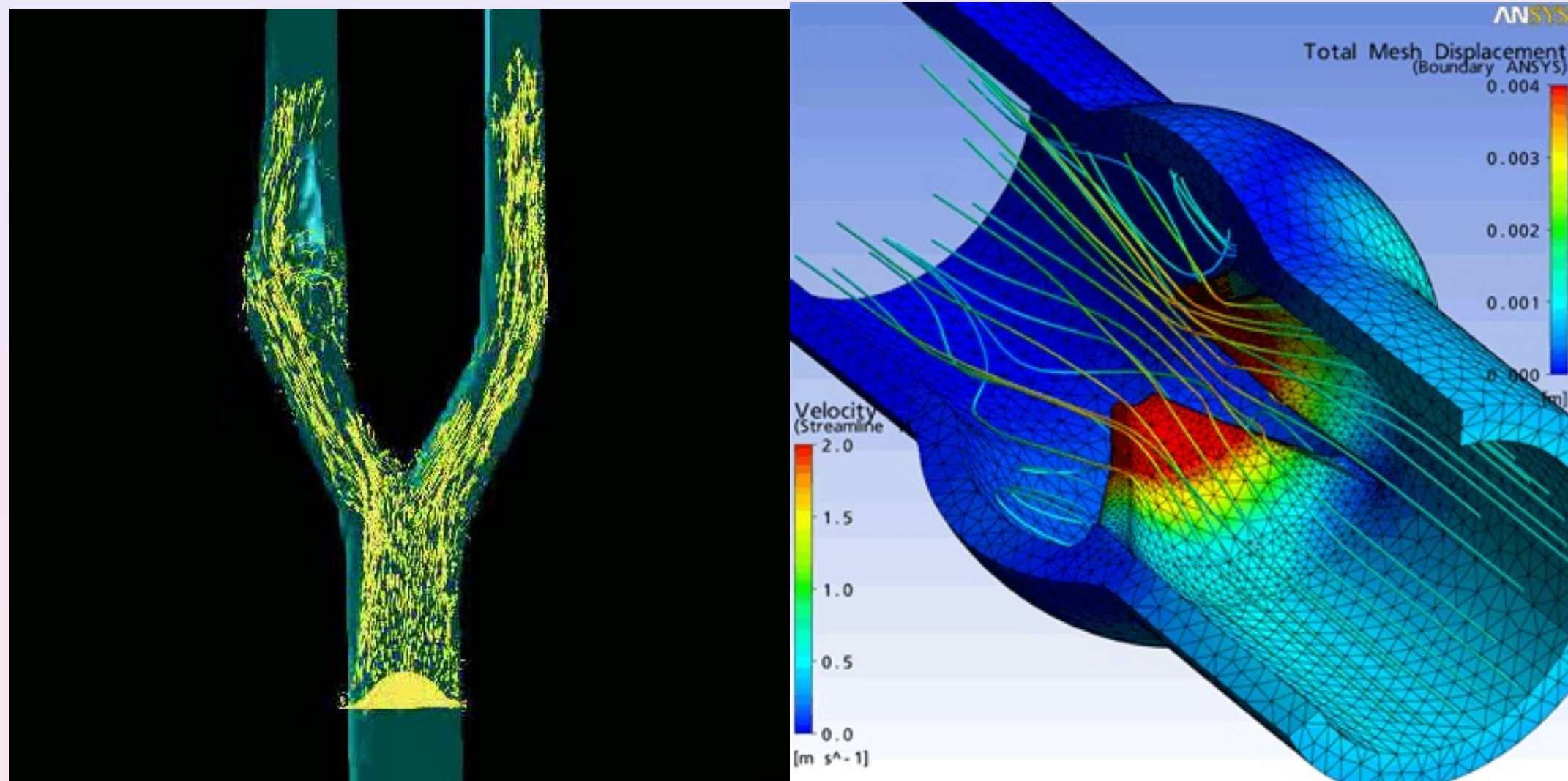

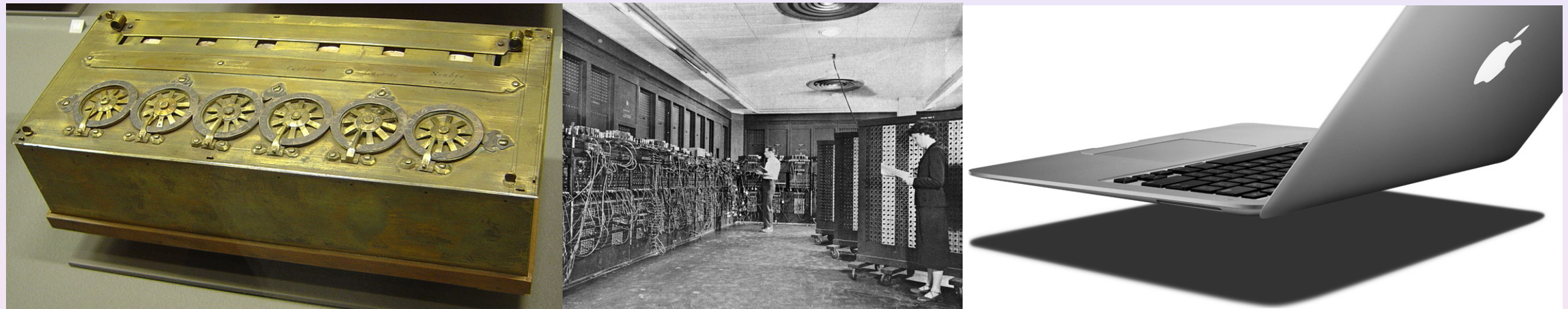

[Pascaline](#), Blaise Pascal, 1645; [ENIAC](#): Electronic Numerical Integrator And Computer, 1946; [Macbook Air](#), 2008.



# Table of Contents

- 1 Control
- 2 The Calculus of Variations
- 3 Controllability
- 4 Optimal Design
- 5 Optimization**
- 6 Perspectives



In mathematics, computational science, or management science, mathematical optimization (alternatively, optimization or mathematical programming) refers to the selection of a best element from some set of available alternatives.

- Convex programming
- Linear programming
- Semidefinite programming
- Conic programming
- Stochastic programming
- Robust programming
- Combinatorial optimization
- Dynamic programming
- Heuristics and metaheuristics
- ....

## An example in logistics

This is a typical and ubiquitous example in linear programming. A company  $s_i$ ,  $i \leq 1 \leq M$  items in each of the  $M$  storage locations.  $N$  clients request  $r_j$  items each,  $1 \leq j \leq N$ . The cost of transportation between the  $i$ -th storage location and the  $j$ -th client is  $c_{ij}$ . We have to decide about the number of items to be delivered from the  $i$ -th storage location the  $j$ -th client,  $v_{ij}$ .

Of course we want to minimize the cost of transportation. The problem is then that of minimizing the functional

$$\inf_{\{v_{ij}\}} \left( \sum_{i=1}^M \sum_{j=1}^N c_{ij} v_{ij} \right)$$

under the constraints

$$v_{ij} \geq 0; \sum_{j=1}^N v_{ij} \leq s_i; \sum_{i=1}^M v_{ij} = r_j, 1 \leq i \leq M; 1 \leq j \leq N.$$

# These tools are so much used that nowadays there is plenty of software available both free and commercial: IPOPT

Last modified on 08/08/11 20:01:00

## Welcome to the Ipopt home page

*Note that these project webpages are based on Wiki, which allows webusers to modify the content to correct typos, add information, or share their experience and tips with other users. You are welcome to contribute to these project webpages. To edit these pages or submit a ticket you must first [register and login](#).*

## Introduction

Ipopt (**I**nterior **P**oint **OPT**imizer, pronounced eye-pea-Opt) is a software package for large-scale [nonlinear optimization](#). It is designed to find (local) solutions of mathematical optimization problems of the form

$$\begin{array}{ll} \min & f(x) \\ \text{x in } & \mathbb{R}^n \\ \\ \text{s.t.} & g_L \leq g(x) \leq g_U \\ & x_L \leq x \leq x_U \end{array}$$

where  $f(x): \mathbb{R}^n \rightarrow \mathbb{R}$  is the objective function, and  $g(x): \mathbb{R}^n \rightarrow \mathbb{R}^m$  are the constraint functions. The vectors  $g_L$  and  $g_U$  denote the lower and upper bounds on the constraints, and the vectors  $x_L$  and  $x_U$  are the bounds on the variables  $x$ . The functions  $f(x)$  and  $g(x)$  can be nonlinear and nonconvex, but should be twice continuously differentiable. Note that equality constraints can be formulated in the above formulation by setting the corresponding components of  $g_L$  and  $g_U$  to the same value.

# Table of Contents

- 1 Control
- 2 The Calculus of Variations
- 3 Controllability
- 4 Optimal Design
- 5 Optimization
- 6 Perspectives**



# We live more and more on a complex network

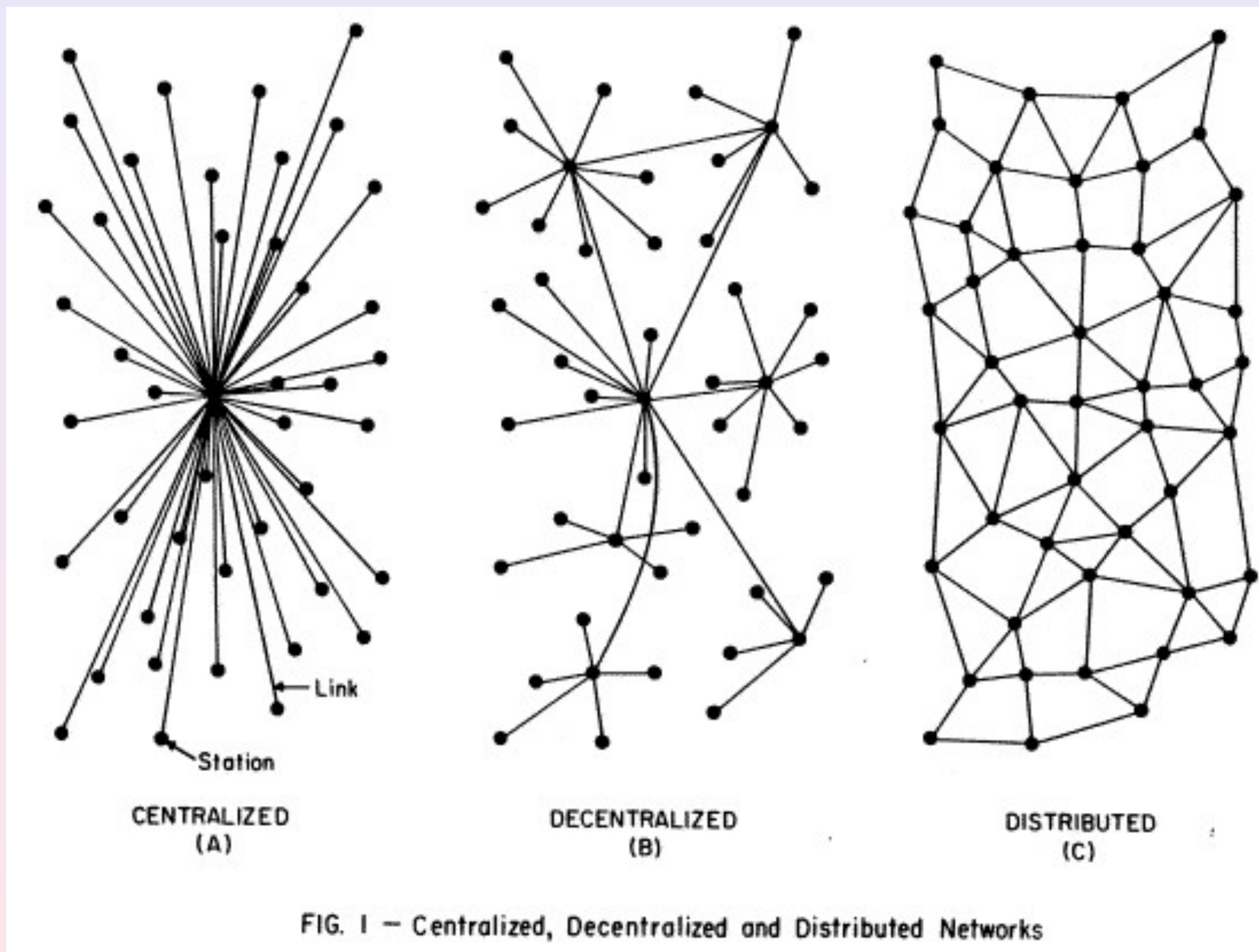

Mathematics are and will be increasingly influenced by the challenge of dealing with **complexity** and **multidisciplinarity**. The following areas will gain relevance:

- Discrete mathematics, combinatorics, graphs,...;
- Data mining/Big data;
- Statistical learning;

and other fields of research such as **neurosciences** and **social sciences**.

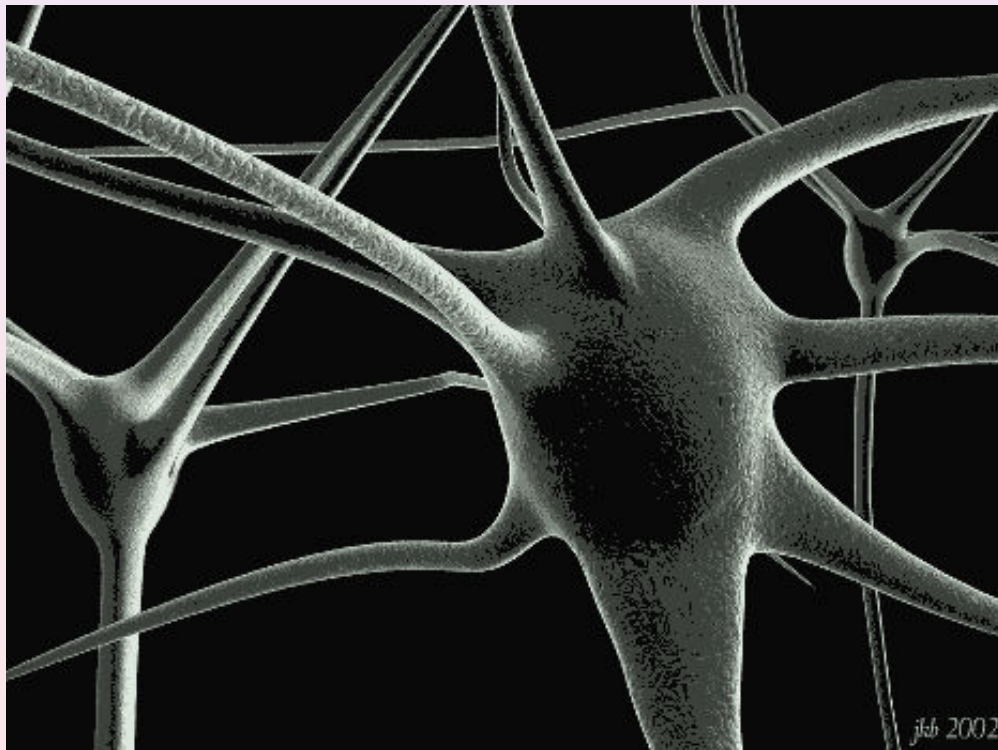



# A mathematician is a machine for turning coffee into theorems

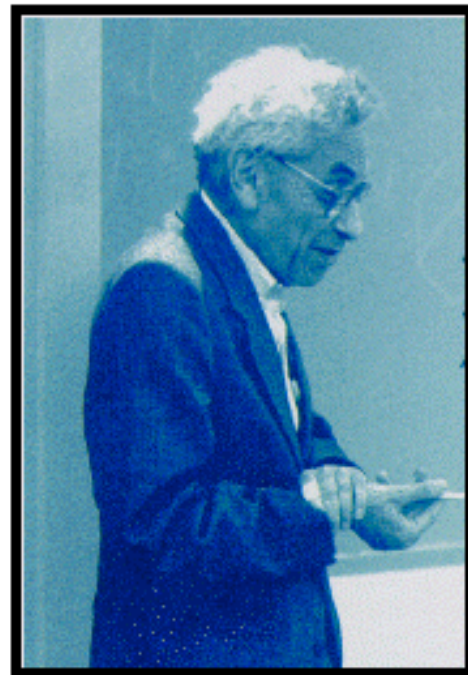

## The Erdős Number Project

This is the website for the Erdős Number Project, which studies research collaboration among mathematicians.

The site is maintained by **Jerry Grossman** at **Oakland University**. **Patrick Ion**, a retired editor at **Mathematical Reviews**, and **Rodrigo De Castro** at the **Universidad Nacional de Colombia, Bogota** provided assistance in the past. Please address all comments, additions, and corrections to Jerry at [grossman@oakland.edu](mailto:grossman@oakland.edu).

**Erdős numbers** have been a part of the **folklore of mathematicians** throughout the world for many years. For an introduction to our project, a description of what Erdős numbers are, what they can be used for, who cares, and so on, choose the "What's It All About?" link below. To find out who **Paul Erdős** is, look at this **biography** at the MacTutor History of Mathematics Archive, or choose the "Information about Paul Erdős" link below. Some useful information can also be found in **this Wikipedia article**, which may or may not be totally accurate.

**Paul Erdős** (1913–1996) was a Hungarian mathematician. He published more papers than any other mathematician in history, working with hundreds of collaborators. He worked on problems in combinatorics, graph theory, number theory, classical analysis, approximation theory, set theory, and probability theory.

# There will be unexpected advances in computing algorithms...

Year	Development	Key early figures
263	Gaussian elimination	Liu, Lagrange, Gauss, Jacobi
1671	Newton's method	Newton, Raphson, Simpson
1795	Least-squares fitting	Gauss, Legendre
1814	Gauss quadrature	Gauss, Jacobi, Christoffel, Stieltjes
1855	Adams ODE formulas	Euler, Adams, Bashforth
1895	Runge–Kutta ODE formulas	Runge, Heun, Kutta
1910	Finite differences for PDE	Richardson, Southwell, Courant, von Neumann, Lax
1936	Floating-point arithmetic	Torres y Quevedo, Zuse, Turing
1943	Finite elements for PDE	Courant, Feng, Argyris, Clough
1946	Splines	Schoenberg, de Casteljau, Bezier, de Boor
1947	Monte Carlo simulation	Ulam, von Neumann, Metropolis
1947	Simplex algorithm	Kantorovich, Dantzig
1952	Lanczos and CG iterations	Lanczos, Hestenes, Stiefel
1952	Stiff ODE solvers	Curtiss, Hirschfelder, Dahlquist, Gear
1954	Fortran	Backus
1958	Orthogonal linear algebra	Aitken, Givens, Householder, Wilkinson, Golub
1959	Quasi-Newton iterations	Davidon, Fletcher, Powell, Broyden
1961	QR algorithm for eigenvalues	Rutishauser, Kublanovskaya, Francis, Wilkinson
1965	Fast Fourier transform	Gauss, Cooley, Tukey, Sande
1971	Spectral methods for PDE	Chebyshev, Lanczos, Clenshaw, Orszag, Gottlieb
1971	Radial basis functions	Hardy, Askey, Duchon, Micchelli
1973	Multigrid iterations	Fedorenko, Bakhvalov, Brandt, Hackbusch
1976	EISPACK, LINPACK, LAPACK	Moler, Stewart, Smith, Dongarra, Demmel, Bai
1976	Nonsymmetric Krylov iterations	Vinsome, Saad, van der Vorst, Sorensen
1977	Preconditioned matrix iterations	van der Vorst, Meijerink
1977	MATLAB	Moler
1977	IEEE arithmetic	Kahan
1982	Wavelets	Morlet, Grossmann, Meyer, Daubechies
1984	interior-point methods	Fiacco, McCormick, Karmarkar, Megiddo
1987	Fast multipole method	Rokhlin, Greengard
1991	Automatic differentiation	Iri, Bischof, Carle, Griewank



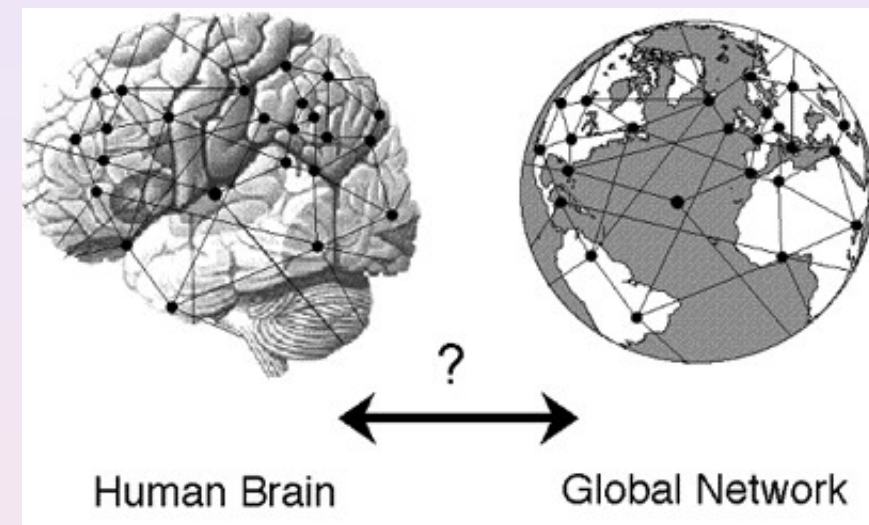
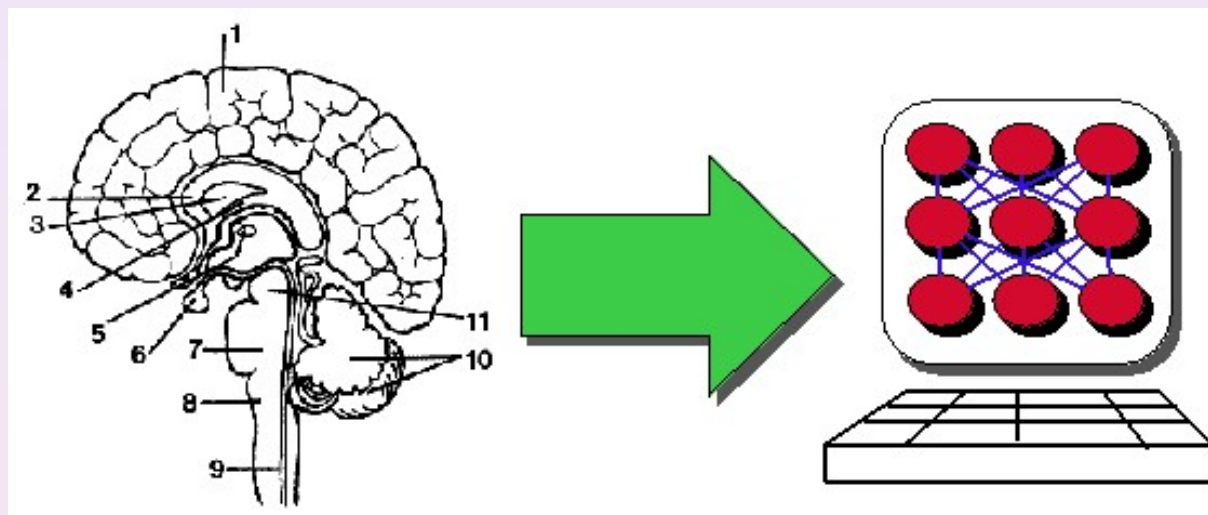

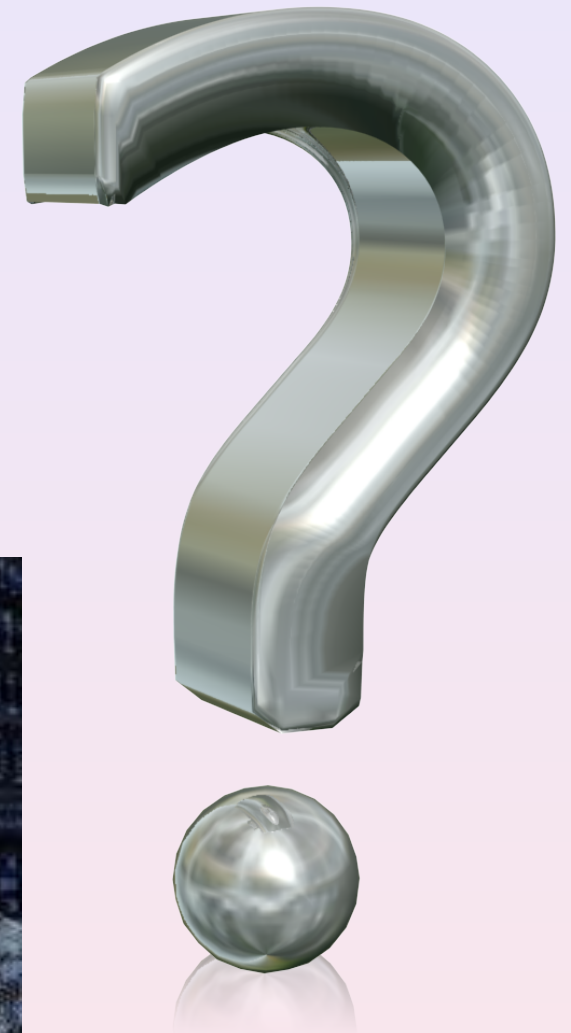
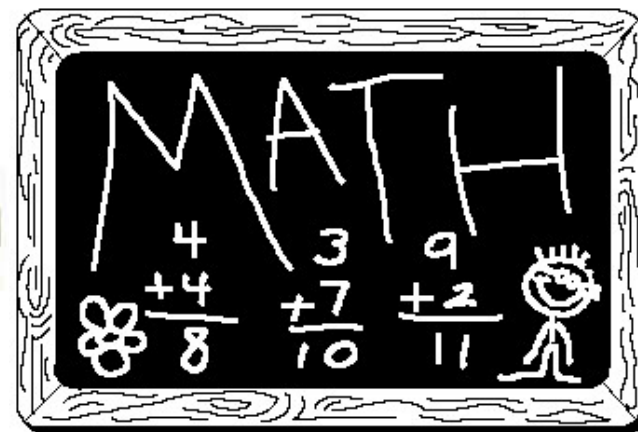
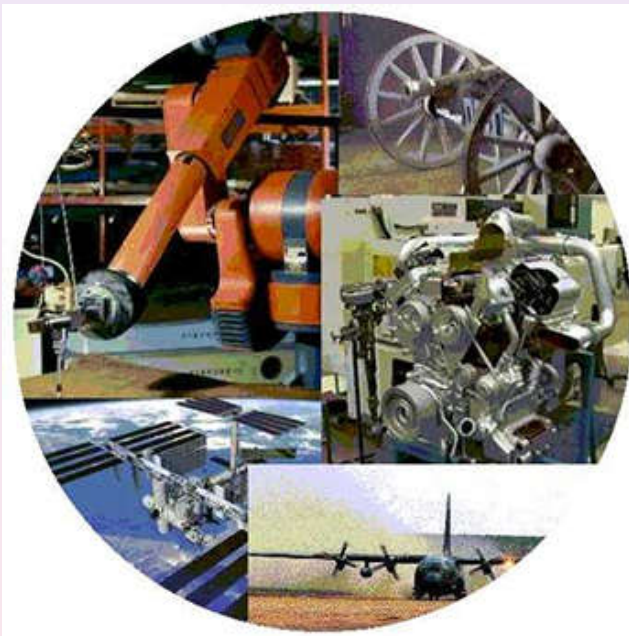

Thanks to:

- [Jean-Michel Coron](http://www.ljll.math.upmc.fr/coron/), Université Pierre et Marie Curie and IUF, France,  
<http://www.ljll.math.upmc.fr/coron/>
- [Aurora Marica](#), University of Graz, Austria
- [Francisco Palacios](http://www.stanford.edu/fasispg/), Stanford University,  
<http://www.stanford.edu/fasispg/>
- [Yannick Privat](http://w3.bretagne.ens-cachan.fr/math/people/yannick.privat), ENS-Cachan, France,  
<http://w3.bretagne.ens-cachan.fr/math/people/yannick.privat>
- [Emmanuel Trélat](http://www.ljll.math.upmc.fr/trelat/), Université Pierre et Marie Curie and IUF, France,  
<http://www.ljll.math.upmc.fr/trelat/>